

Anritsu envision : ensure

VNA Master™

The Ultimate Handheld Vector Network +
Spectrum Analyzer for Cable, Antenna, and
Signal Analysis Anytime, Anywhere

MS2026C, MS2027C, MS2028C

5 kHz to 6 GHz, 15 GHz, 20 GHz Vector Network Analyzer

MS2036C, MS2037C, MS2038C

5 kHz to 6 GHz, 15 GHz, 20 GHz Vector Network Analyzer

9 kHz to 9 GHz, 15 GHz, 20 GHz Spectrum Analyzer

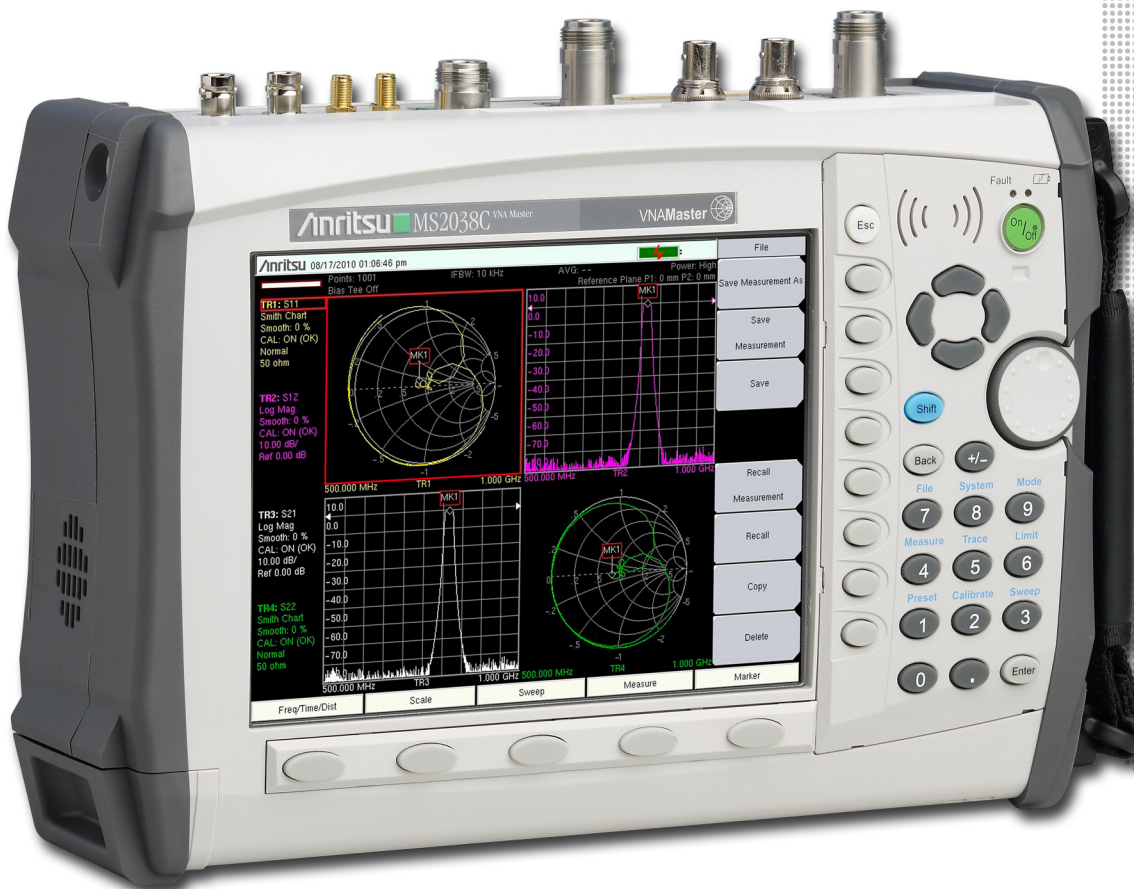

Introduction

High Performance Handheld S-Parameters — Meet the MS202xC/3xC VNA Master + Spectrum Analyzer, the industry's broadest frequency handheld solution to address cable, antenna, component, and signal analysis needs in the field with frequency coverage from 5 kHz up to 20 GHz. Equally impressive, this broadband measurement tool offers the industry's first 12-term error correction algorithm in a truly handheld, battery-operated, rugged multi-function instrument. Optional Time Domain with Low Pass Step response and Real Impedance graph delivers standard TDR-type display results. Time Domain also includes a standard gating function.

The MS203xC models include a powerful spectrum analyzer that multiplies user convenience by combining spectrum analysis with the VNA into a single measurement powerhouse for the harsh RF and physical environments of field test.

Whether it is for spectrum monitoring, broadcast proofing, interference analysis, RF and microwave measurements, regulatory compliance, or 3G/4G and wireless data network measurements, this VNA/Spectrum Analyzer combination is the ideal instrument for making fast and reliable measurements in the field.



VNA Master™ MS202xC/MS203xC Vector Network Analyzer + Spectrum Analyzer
 Size: 315 mm x 211 mm x 78/97mm (12.4 in x 8.3 in x 3.1/3.8 in), Lightweight: 4.5 kg to 4.8 kg (9.9 lb to 10.5 lb)

Vector Network Analyzer Performance and Functional Highlights (All Models)

- Broadband coverage of 5 kHz to up to 20 GHz
- True 2-path, 2-port Vector Network Analyzer
- Ultimate accuracy with 12-term error correction
- High Performance Handheld S-Parameters
- User-defined Quad Display for viewing all 4 S-Parameters
- Arbitrary data points up to 4001
- IF Bandwidth selections of 10 Hz to 100 kHz
- Directivity:
 - > 42 dB up to 6 GHz (all models)
 - > 36 dB > 6 GHz up to 20 GHz (all models)
- Supports Reciprocal Through Calibration types (SOLR, SSLR, SSSR)
- All models support waveguide measurements
- 350 μ s/data point sweep speed
- USB/Ethernet for PC data transfer and control
- Automate repetitive tasks via Ethernet & USB
- PIM Hunting
- Field upgradeable firmware
- Operation to +55 °C: full performance on AC or battery
- Store more than 4000 traces and setups in memory
- Portable: 4.5/4.8 kg (9.9/10.5 lb)
- Time Domain (with gating) option
- Internal Bias Tee option
- Vector Voltmeter option
- High Accuracy Power Meter option
- Differential option (S_{d1d1} , S_{c1c1} , S_{d1c1} , and S_{c1d1})
- Secure Data Operation option for safe use in high security environments
- GPS Receiver option
- Low Pass Stepped Response and Real Impedance graph type provide TDR functionality (standard capability with Time Domain option)
- Multiple display formats including Polar and Real Impedance
- Supports Anritsu USB Power Sensors
- 8.4 in, 800 x 600 high resolution, daylight-viewable TFT color display
- Complies with MIL-PRF-28800F Class 2, Certified for use in Explosive Atmosphere per MIL-PRF-28800F and MIL-STD-810G

Spectrum Analyzer Performance and Functional Highlights (MS203XC Models Only)

- Measure: Occupied Bandwidth, Channel Power, ACPR, C/I
- Dynamic Range: > 106 dB in 1 Hz RBW
- DANL: -164 dBm in 1 Hz RBW
- Phase Noise: -106 dBc/Hz @ 10 kHz offset at 1 GHz
- GPS-Enhanced Frequency Accuracy: < \pm 25 ppb with GPS On and locked. GPS-Enhanced Frequency Accuracy is retained after GPS unlock at < 50 ppb for 72 hours, 0 °C to 50 °C
- 1 Hz to 10 MHz Resolution Bandwidth (RBW)
- Traces: Normal, Max Hold, Min Hold, Average, # of Averages
- Detectors: Peak, Negative, Sample, Quasi-peak, and true RMS
- Markers: 6, each with a Delta Marker, or 1 Reference with 6 Deltas
- Limit Lines: up to 40 segments with one-button envelope creation
- Trace Save-on-Event: crossing limit line or sweep complete
- Option to automatically optimize sweep-RBW-VBW trade-off for best possible display
- Interference Analyzer Option: Spectrogram, Signal Strength, RSSI
- Standard Burst Detect: 1000X faster sweep with spans up to 15 MHz. Captures intermittent signals as narrow as 200 μ S every time.
- GPS tagging of stored traces
- Internal Preamplifier standard
- High Accuracy Power Meter Option
- AM/FM/SSB Demodulation (audio only)
- Optional AM/FM/PM Analyzer
- Optional Coverage Mapping
- Optional Channel Scanner

Table of Contents

Definitions	4
VNA Performance Specifications	5
VNA Functional Specifications	6
Corrected System Performance and Uncertainties — High Port Power	7
Distance Domain Specifications	11
Time Domain (Option 2) Specifications	11
Option Comparison Table (Distance Domain and Time Domain)	11
Secure Data Operation (Option 7)	11
Bias Tee (Option 10)	12
Balanced/Differential S-Parameters, 1-Port (Option 77)	12
Vector Voltmeter (Option 15)	12
Spectrum Analyzer Performance Specifications (MS203xC only)	13
High Accuracy Power Meter (Option 19)	15
Interference Analyzer (Option 25)	15
Channel Scanner (Option 27)	15
Coverage Mapping (Option 431)	16
GPS Receiver (Option 31)	16
AM/FM/PM Signal Analyzer (Option 509, MS203xC only)	16
General Specifications	18
Line Sweep Tools™	19
Master Software Tools	20
Ordering Information	21
Related Literature, Application Notes, Manuals	21
Standard Accessories	22
Optional Accessories	22

Definitions

	All specifications and characteristics apply to Revision 2 instruments under the following conditions, unless otherwise stated:
Warm-Up Time	After 15 minutes of warm-up time in VNA mode, where the instrument is left in the ON state.
Temperature Range	Over the 23 °C ± 5 °C temperature range.
Reference Signal	When using internal reference signal.
Spectrum Analyzer	After 5 minutes of warm-up time, where the instrument is left in the ON state and Sweep Mode set to Performance.
Typical Performance	Typical specifications that are not in parenthesis are not tested and not warranted. They are generally representative of characteristic performance. Typical specifications in parenthesis () represent the mean value of measured units and do not include any guard-bands or uncertainties. They are not warranted.
Uncertainty	A coverage factor of x1 is applied to the "VNA" or "corrected system" measurement uncertainties to facilitate comparison with other industry handheld analyzers.
Calibration Cycle	Calibration is within the recommended 12 month period (residual specifications also require calibration kit calibration cycle adherence.)
	All specifications subject to change without notice. For the most current data sheet, please visit the Anritsu web site: www.anritsu.com



VNA Performance Specifications

Block Diagram

Simplified block diagram of the VNA Master has a 2-port, 2-path architecture that automatically measures four S-parameters with a single connection.

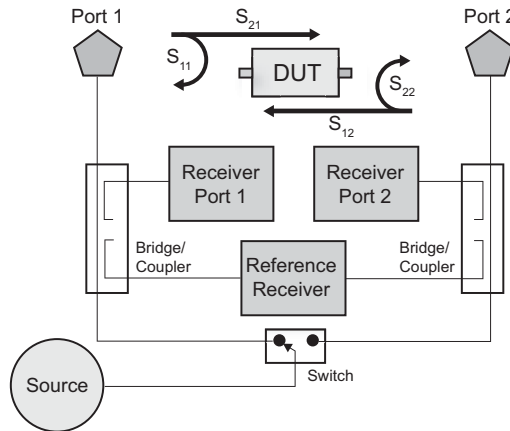

Frequency

Frequency Range	MS2026C/36C: 5 kHz to 6 GHz MS2027C/37C: 5 kHz to 15 GHz MS2028C/38C: 5 kHz to 20 GHz
Frequency Accuracy	±1.5 ppm
Frequency Resolution	1 Hz to 375 MHz, 10 Hz to 6 GHz, and 100 Hz to 20 GHz

Test Port Power

VNA Master supports selection of either High (default) or Low test port power. Changing power after calibration can degrade the calibrated performance.

Frequency Range	High Port Power (dBm)	Low Port Power (dBm)	(all values typical)
5 kHz to 3 GHz	+3	-25	
> 3 GHz to 6 GHz	-3	-25	
> 6 GHz to 20 GHz	-3	-15	

Transmission Dynamic Range (difference between test port power and noise floor) using 10 Hz IF Bandwidth and High Port Power

Frequency Range	Transmission Dynamic Range (dB)
5 kHz to 2 MHz	85 dB
> 2 MHz to 3 GHz	100 dB
> 3 GHz to 6 GHz	90 dB
> 6 GHz to 20 GHz	85 dB

Sweep Speed

The typical sweep speed in $\mu\text{s}/\text{point}$ for IF Bandwidth of 100 kHz, 1001 data points, and single display is shown for the following frequencies. The three receiver architecture will simultaneously collect S_{21} and S_{11} (or S_{12} and S_{22}) in a single sweep

Frequency Range	Sweep Speed
5 kHz to 6 GHz	350 $\mu\text{s}/\text{point}$ typical
> 6 GHz to 20 GHz	650 $\mu\text{s}/\text{point}$ typical

High-Level Noise S_{11} or S_{22} , Short, Power = High, IFBW = 200 Hz, typical

Frequency Range	Magnitude	Phase
5 kHz to 6 GHz	0.004 dB (rms)	0.040 deg
> 6 GHz to 20 GHz	0.010 dB (rms)	0.050 deg

Noise Floor 10 Hz IFBW

Frequency	Noise Floor
5 kHz to 2 MHz	-85 dBm typical
> 2 MHz to 3 GHz	-100 dBm typical
> 3 GHz to 6 GHz	-96 dBm typical
> 6 GHz to 20 GHz	-91 dBm typical

Temperature Stability S_{11} or S_{22} , Short, 23 °C ± 5 °C, typical

Frequency Range	Magnitude	Phase
5 kHz to 10 GHz	0.018 dB/°C	0.160 deg/°C
> 10 GHz to 20 GHz	0.070 dB/°C	0.800 deg/°C



VNA Functional Specifications

Measurement Parameters	S_{11} , S_{21} , S_{22} , S_{12} , (optionally: S_{d1d1} , S_{c1c1} , S_{d1c1} , S_{c1d1})
Number of Traces	Four: TR1, TR2, TR3, TR4
Trace Format	Single, Dual, Tri, Quad, with Trace overlay capabilities
Graph Types	Log Magnitude, SWR, Phase, Real, Imaginary, Group Delay, Smith Chart, Inverted Smith Chart (Admittance), Log Mag/2 (1-Port Cable Loss), Linear Polar, Log Polar, Real Impedance, Imaginary Impedance
Domains	Frequency Domain, Distance Domain, Time Domain with gating (Time Domain optional)
Frequency	Start Frequency, Stop Frequency, Center Frequency, Span
Distance	Start Distance, Stop Distance
Time	Start Time, Stop Time
Frequency Sweep Type: Linear	Single Sweep, Continuous
Data Points	2 to 4001 (arbitrary setting); data points can be reduced without recalibration.
Limit Lines	Upper, Lower, 10-segmented Upper, 10-segmented Lower
Test Limits	Pass/Fail for Upper, Pass/Fail for Lower, Limit Audible Alarm
Data Averaging	Sweep-by-sweep
Smoothing	0 % to 20 %
IF Bandwidth (Hz)	10, 20, 50, 100, 200, 500, 1k, 2k, 5k, 10k, 20k, 50k, 100k
Reference Plane	The reference planes of a calibration (or other normalization) can be changed by entering a line length. Assumes no loss, flat magnitude, linear phase, and constant impedance.
Auto Reference Plane Extension	Instead of manually entering a line length, this feature automatically adjusts phase shift from the current calibration (or other normalization) to compensate for external cables (or test fixtures). Assumes no loss, flat magnitude, linear phase, and constant impedance.
Group Delay Aperture	Defined as the frequency span over which the phase change is computed at a given frequency point. The aperture can be changed without recalibration. The minimum aperture is the frequency range divided by the number of points in calibration and can be increased to 20 % of the frequency range.
Group Delay Range	< 180° of phase change within the aperture
Trace Memory	A separate memory for each trace can be used to store measurement data for later display. The trace data can be saved and recalled.
Trace Math	Complex trace math operations of subtraction, addition, multiplication, or division are provided.
Number of Markers	12, arbitrary assignments to any trace
Marker Types	Reference, Delta
Marker Readout Styles	Log Mag, Cable Loss (Log Mag / 2), Log Mag and Phase, Phase, Real and Imaginary, SWR, Impedance, Admittance, Normalized Impedance, Normalized Admittance, Polar Impedance, and Group Delay, Linear Mag, Linear Mag and Phase
Marker Search	Peak Search, Valley Search, Find Marker Value
Correction Models	Full 2-Port, Full S_{11} , Full S_{22} , Full S_{11} & S_{22} , Response S_{21} , Response S_{12} , Response S_{21} & S_{12} , Response S_{11} , Response S_{22} , Response S_{11} & S_{22} , One-Path Two-Port (S_{11}, S_{21}), One-Path Two-Port (S_{22}, S_{12})
Calibration Types	Flex, Standard
Calibration Methods	Short-Open-Load-Through (SOLT), Offset-Short (SSLT), and Triple-Offset-Short (SSST), Short-Open-Load-Reciprocal (SOLR), Double-Offset-Short-Load-Reciprocal (SSLR), Triple-Offset-Short-Reciprocal (SSSR)
Calibration Standard Coefficients	Coax: N-Connector, K-Connector, 7/16, TNC, SMA, and four User Defined coax types Waveguide: WG11A, WG12, WG13, WG14, WG15, WG16, WG17, WG18, WG20, and four User Defined rectangular waveguide types
Cal Correction Toggle	On/Off
Interpolation	On/Off
Dispersion Compensation	Waveguide correction that improves accuracy of distance-to-fault data by compensating for different wavelengths propagating at different speeds.
Impedance Conversion	Support for 50 Ω and 75 Ω are provided.
Units	Meters, Feet
Bias Tee Settings	Internal, External, Off
Timebase Reference	Internal, External
File Storage Types	Measurement (.mna), Setup (.stp, with or without CAL), S2P (Real/Imag), S2P (Lin Mag/Phase), S2P (Log Mag/Phase), Text (VNA Only), CSV (VNA Only), JPEG
Ethernet Configuration	DHCP or Manual (Static) IP configuration, 10/100 Base-T, RJ45 jack
Languages	English, French, German, Spanish, Chinese, Japanese, Korean, Italian, Russian, Portuguese (Português)

Corrected System Performance and Uncertainties — High Port Power

Measurement Accuracy¹ (OSLN50A-18 or TOSLN50A-18)

Frequency Range	Directivity (dB)	Source Match (dB)	Load Match (dB)	Reflection Tracking (dB)	Transmission Tracking (dB)
5 kHz to 20 MHz	≥ 42	≥ 30	≥ 42	± 0.02	± 0.01
> 20 MHz to 3 GHz	≥ 42	≥ 30	≥ 42	± 0.07	± 0.01
> 3 GHz to 6 GHz	≥ 42	≥ 30	≥ 42	± 0.05	± 0.02
> 6 GHz to 20 GHz ²	≥ 33	≥ 24	≥ 33	± 0.2	± 0.1

Transmission Uncertainty (S_{21}, S_{12})²

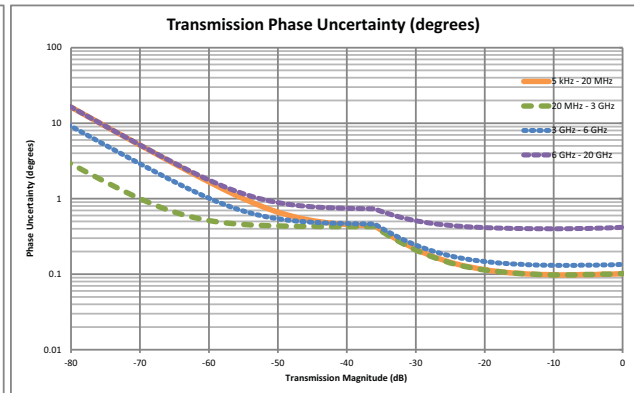
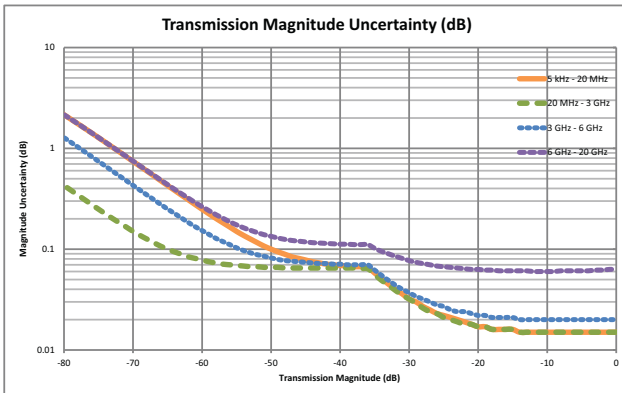

Reflection Uncertainty (S_{11}, S_{22})²

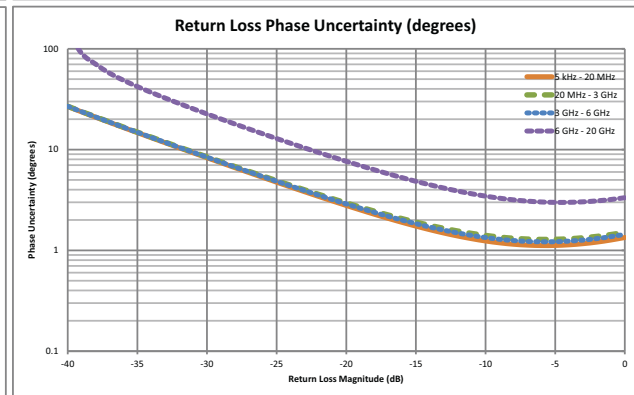
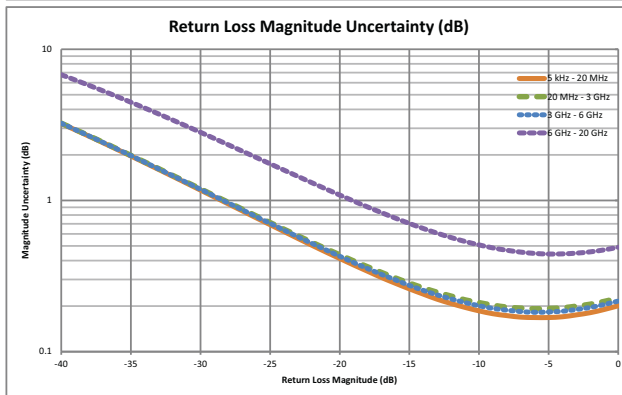

1. Full 2-Port calibration, Default Power, 10 Hz IFBW, No averaging, 10 minute warm-up. OSLN50A-18 or TOSLN50A-18 calibration kit. Load match specification applicable directly at corrected port only. De-rate by approximately 8 dB if using a 3670 series test port cable. Reflection and Transmission Tracking are typical.
 2. Specified only to 18 GHz, typical above 18 GHz.

Corrected System Performance and Uncertainties — High Port Power (continued)

Measurement Accuracy¹ (OSLNF50A-18, or TOSLNF50A-18)

Frequency Range	Directivity (dB)	Source Match (dB)	Load Match (dB)	Reflection Tracking (dB)	Transmission Tracking (dB)
5 kHz to 20 MHz	≥ 42	≥ 30	≥ 42	± 0.02	± 0.01
> 20 MHz to 3 GHz	≥ 42	≥ 30	≥ 42	± 0.07	± 0.01
> 3 GHz to 6 GHz	≥ 42	≥ 30	≥ 42	± 0.05	± 0.02
> 6 GHz to 20 GHz ²	≥ 33	≥ 24	≥ 33	± 0.2	± 0.1

Transmission Uncertainty (S_{21}, S_{12})²

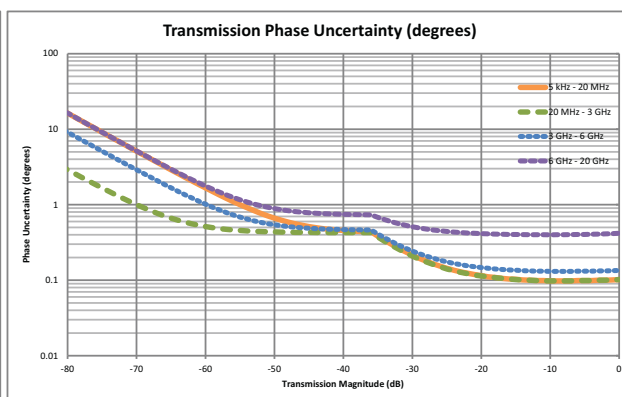
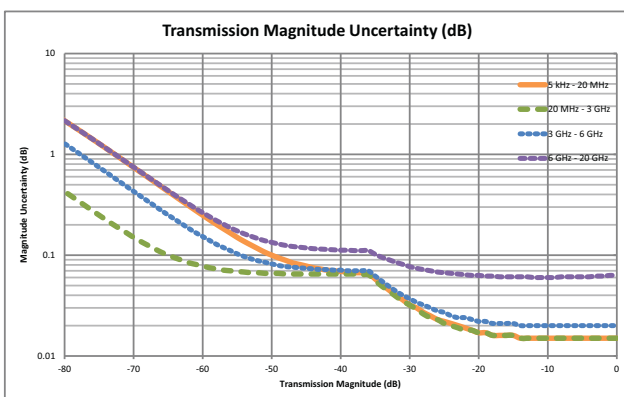

Reflection Uncertainty (S_{11}, S_{22})²

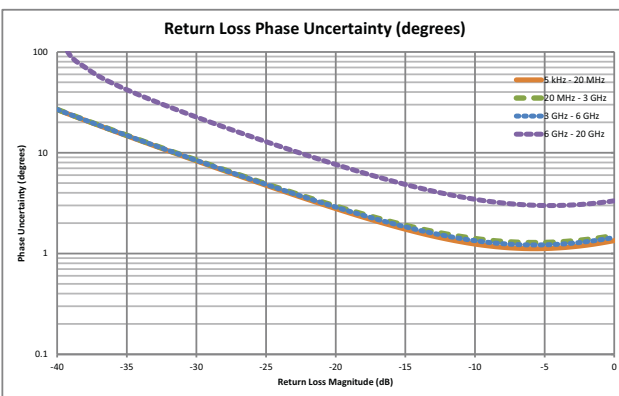
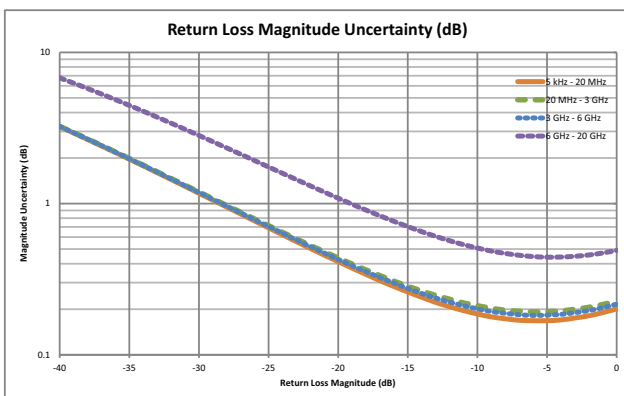

1. Full 2-Port calibration, Default Power, 10 Hz IFBW, No averaging, 10 minute warm-up. OSLNF50A-18 or TOSLNF50A-18 calibration kit. Load match specification applicable directly at corrected port only. De-rate by approximately 8 dB if using a 3670 series test port cable. Reflection and Transmission Tracking are typical.
 2. Specified only to 18 GHz, typical above 18 GHz.

Corrected System Performance and Uncertainties — High Port Power (continued)

Measurement Accuracy¹ (TOSLK50A-20 or TOSLK50A-40)

Frequency Range	Directivity (dB)	Source Match (dB)	Load Match (dB)	Reflection Tracking (dB)	Transmission Tracking (dB)
5 kHz to 20 MHz	≥ 42	≥ 33	≥ 42	± 0.02	± 0.01
> 20 MHz to 3 GHz	≥ 42	≥ 33	≥ 42	± 0.07	± 0.01
> 3 GHz to 6 GHz	≥ 42	≥ 33	≥ 42	± 0.05	± 0.02
> 6 GHz to 20 GHz	≥ 36	≥ 26.5	≥ 36	± 0.2	± 0.1

Transmission Uncertainty (S_{21} , S_{12})

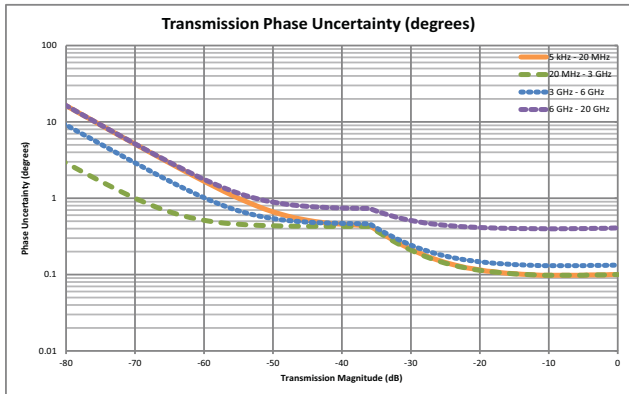
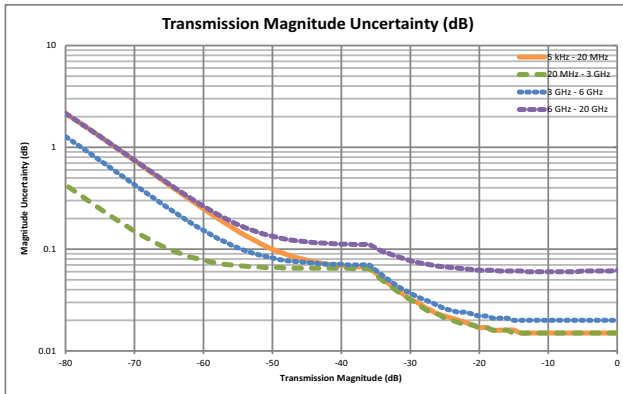

Reflection Uncertainty (S_{11} , S_{22})

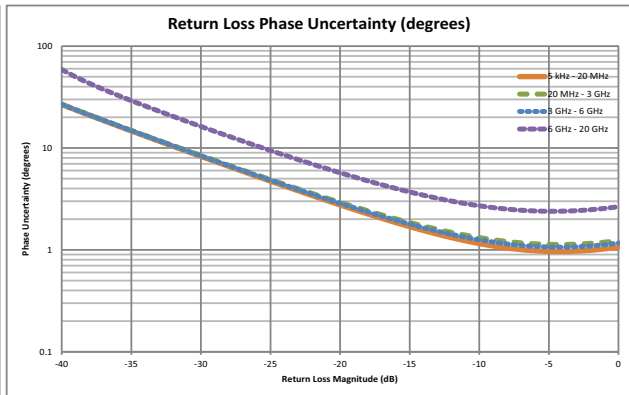
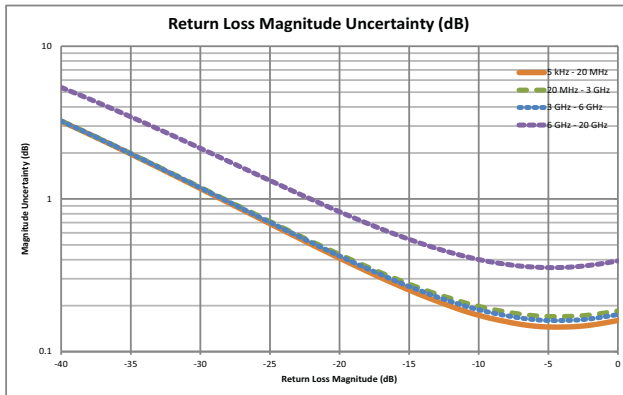

1. Full 2-Port calibration, Default Power, 10 Hz IFBW, No averaging, 10 minute warm-up. TOSLK50A-20 or TOSLK50A-40 calibration kit. Load match specification applicable directly at corrected port only. De-rate by approximately 8 dB if using a 3670 series test port cable. Reflection and Transmission Tracking are typical.

Corrected System Performance and Uncertainties — High Port Power (continued)

Measurement Accuracy¹ (TOSLKF50A-20, or TOSLKF50A-40)

Frequency Range	Directivity (dB)	Source Match (dB)	Load Match (dB)	Reflection Tracking (dB)	Transmission Tracking (dB)
5 kHz to 20 MHz	≥ 42	≥ 33	≥ 42	± 0.02	± 0.01
> 20 MHz to 3 GHz	≥ 42	≥ 33	≥ 42	± 0.07	± 0.01
> 3 GHz to 6 GHz	≥ 42	≥ 33	≥ 42	± 0.05	± 0.02
> 6 GHz to 20 GHz	≥ 36	≥ 26.5	≥ 36	± 0.2	± 0.1

Transmission Uncertainty (S_{21} , S_{12})

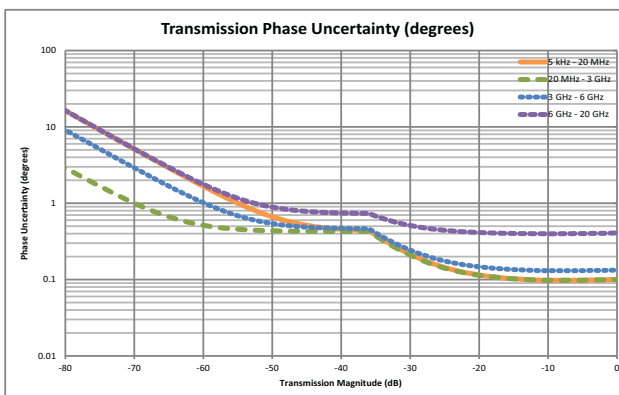
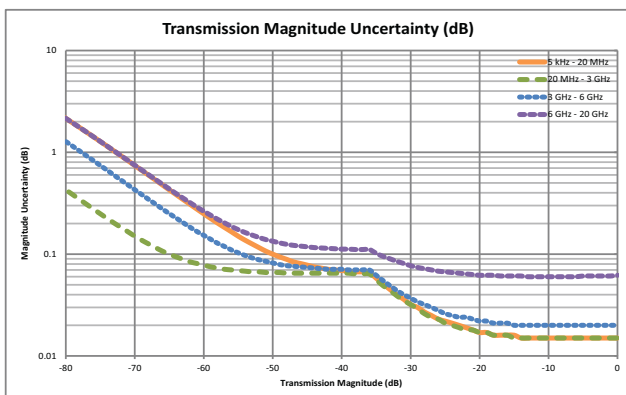

Reflection Uncertainty (S_{11} , S_{22})

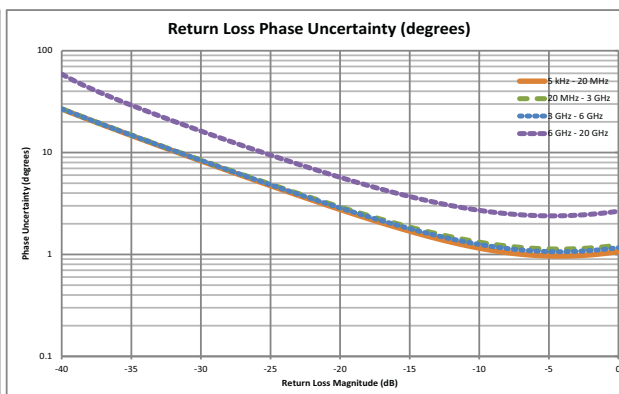
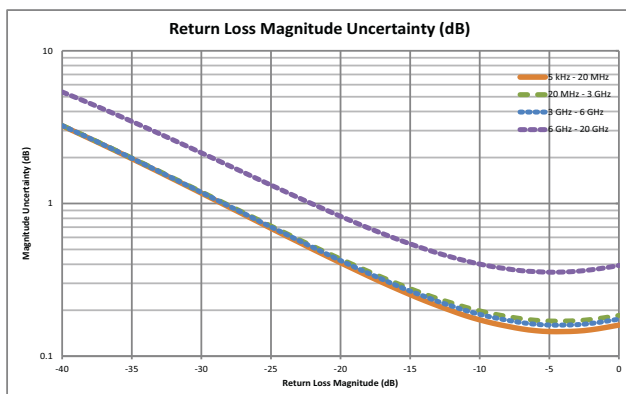

1. Full 2-Port calibration, Default Power, 10 Hz IFBW, No averaging, 10 minute warm-up. TOSLKF50A-20 or TOSLKF50A-40 calibration kit. Load match specification applicable directly at corrected port only. De-rate by approximately 8 dB if using a 3670 series test port cable. Reflection and Transmission Tracking are typical.



Distance Domain Specifications (formerly Option 501, now standard with firmware revision v1.16 or higher)

Distance Domain Analysis is a powerful field test tool to analyze cables for faults, including minor discontinuities that may occur due to a loose connection, corrosion, or other aging effects. By using Frequency Domain Reflectometry (FDR), the VNA Master exploits a user-specified band of full power operational frequencies (instead of DC pulses from TDR approaches) to more precisely identify cable discontinuities. The VNA Master converts S-parameters from frequency domain into distance domain on the horizontal display axis, using a mathematical computation called Inverse Fourier Transform. Connect a reflection at the opposite end of the cable, and the discontinuities appear versus distance to reveal any potential maintenance issues. When access to both ends of the cable is convenient, a similar distance domain analysis is available on transmission measurements.

Distance Domain will improve your productivity with displays of the cable in terms of discontinuities versus distance. This readout can then be compared against previous measurements (from stored data) to determine whether any degradations have occurred since installation (or the last maintenance activity). More importantly, you will know precisely where to go to fix the problem and so minimize or prevent downtime of the system.

Round-Trip (reflection)	
Fault Resolution (meters)	$(0.5 \times c \times Vp) / \Delta F$; (c is speed of light = 299,792,458 m/s, ΔF is F2 - F1 in Hz)
One-Way (transmission)	
Fault Resolution (meters)	$(c \times Vp) / \Delta F$; (c is speed of light = 299,792,458 m/s, ΔF is F2 - F1 in Hz)
Horizontal Range (meters)	0 to (data points - 1) x Fault Resolution to a maximum of 3000 m (9843 ft)
Windowing	Rectangular, Nominal Side Lobe (NSL), Low Side Lobe (LSL), and Minimum Side Lobe (MSL)



Time Domain (Option 2) Specifications (includes Distance Domain)

The VNA Master can display the S-parameter measurements in the time or distance domain using lowpass or bandpass processing analysis modes. The broadband frequency coverage coupled with 4001 data points means you can measure discontinuities both near and far with unprecedented clarity for a handheld tool.

With this option, you can simultaneously view S-parameters in frequency, time, and distance domain to quickly identify faults in the field. Advanced features available with this option include step response, phasor impulse, gating, and frequency gated in time. The option includes computational routines that further enhance the Distance Domain results by compensating for cable loss, relative velocity of propagation, and dispersion compensation in waveguide. See the Distance Domain Specifications above.



Option Comparison Table (Distance Domain and Time Domain)

Measurement	Distance Domain (formerly Option 501)	Option 2 Time Domain
Distance-to-Fault	X	X
Distance Domain display	X	X
Windowing	X	X
Distance of Waveguide		X
Time Domain display		X
One Way vs. Round Trip Reflection		X
Phasor Impulse		X
Impulse Response		X
Step Response		X
Low Pass vs. Bandpass		X
Frequency Gated by Time		X
Frequency Gated by Distance		X



Secure Data Operation (Option 7)

For highly secure data handling requirements, this software option prevents the storing of measurement setup or data information onto any internal file storage location. Instead, setup and measurement information is stored ONLY to the external USB memory location. A simple factory preset prepares the VNA Master for transportation while the USB memory remains behind in the secure environment. The VNA Master cannot be switched between secure and non-secure operation by the user once configured for secure data operation. With this option enabled, the user can also choose to blank the frequency values displayed on the screen.



Bias Tee (Option 10)

For tower mounted amplifier tests, the MS20x/3xC series with optional internal bias tees can supply both DC and RF signals on the center conductor of the cable during measurements. For frequency sweeps in excess of 2 MHz, the VNA Master can supply internal voltage control from +12 V to +32 V in 0.1 V steps up to 450 mA. To extend battery life, an external power supply can substitute for the internal supply by using the included external bias ports. Both test ports can be configured to supply voltage via this integrated bias tees option. Bias can be directed to VNA Port 1 or Port 2.

Bias Tee Specifications The VNA Master offers optional integrated bias tee for supplying DC plus RF0 to the DUT as shown in the simplified block diagram. Connectivity is also provided for external supply (instead of internal) to preserve battery consumption.

Frequency Range	2 MHz to 6 GHz (MS20x6C) 2 MHz to 15 GHz (MS20x7C) 2 MHz to 20 GHz (MS20x8C)
Internal Voltage/Current	+12 V to +32 V at 450 mA steady rate
Internal Resolution	0.1 V
External Voltage/Current	± 50 V at 500 mA steady rate
Bias Tee Selections	Internal, External, Off

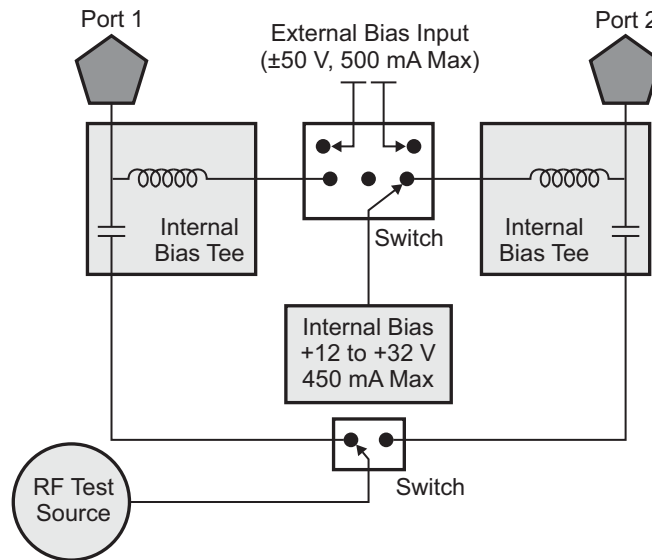

Balanced/Differential S-Parameters, 1-Port (Option 77)

As an alternative to a sampling oscilloscope, verifying the performance and identifying discontinuities in high-data-rate differential cables is now possible with the VNA Master. After a full two-port calibration, connect your differential cable directly to the two test ports and reveal the S_{d1d1} performance, which is essentially differential return loss, or any of the other differential S-Parameters, S_{c1c1} , S_{d1c1} , or S_{c1d1} . With optional time domain, you can convert frequency sweeps to distance. This capability is especially valuable for applications in high data rate cables where balanced data formats are used to isolate noise and interference.



Vector Voltmeter (Option 15)

A phased array system relies on phase matched cables for nominal performance. For this class of application, the VNA Master offers this special software mode to simplify phase matching cables at a single frequency. The similarity between the popular vector voltmeter and this software mode ensures minimal training is required to phase match cables. Operation is as simple as configuring the display for absolute or relative measurements. The easy-to-read large fonts show either reflection or transmission measurements using impedance, magnitude, or VSWR readouts. For instrument landing system (ILS) or VHF Omni-directional Range (VOR) applications, a table view improves operator efficiency when phase matching up to twelve cables. The MS202x/3xC solution is superior because the signal source is included internally, precluding the need for an external signal generator.

VVM Specifications

CW Frequency Range	5 kHz to 6 GHz (MS20x6C) 5 kHz to 15 GHz (MS20x7C) 5 kHz to 20 GHz (MS20x8C)
Measurement Display	CW, Table (Twelve Entries, Plus Reference)
Measurement Types	Return Loss, Insertion
Measurement Format	dB/VSWR/Impedance



Spectrum Analyzer Performance Specifications (MS203xC only)

Measurements

Smart Measurements	Field Strength (dBm/m ² , dBV/m, dBmV/m, dBμV/m, V/m, Watt/m ² , dBW/m ² , A/m, dBA/m, or Watt/cm ²) Occupied Bandwidth (measures 99 % to 1 % power channel of a signal, or N dB from center of signal) Channel Power (measures the total power in a specified bandwidth) ACPR (Adjacent Channel Power Ratio) Emission Mask (recall limit lines as emission mask) Spurious Emissions (measures up to 32 segments with independent setups and limits) C/I (Carrier-to-Interference ratio) AM/FM/SSB Demodulation (AM, wide/narrow FM, upper/lower SSB (audio only)) PIM Hunting
--------------------	---

Setup Parameters

Frequency	Center/Start/Stop, Span, Freq Step, Freq Offset, Signal Standard, Channel #, Channel Increment
Amplitude	Reference Level (RL), Scale, Attenuation Auto/Level, RL Offset, Units (dBm, dBV, dBmV, dBμV, Volt, Watt, dBW, A, dBA), Pre-Amp On/Off, Detection (Peak, RMS/Avg, Negative Peak, Sample, Quasi-Peak)
Span	Span, Span Up/Down (1-2-5), Full Span, Zero Span, Last Span
Bandwidth	RBW, Auto RBW, VBW, Auto VBW, VBW/Avg Type (Linear, Log), RBW/VBW Ratio, Span/RBW Ratio
Impedance	50 Ω, 75 Ω; external pad required for 75 Ω operation

Sweep Functions

Sweep	Single/Continuous, Sweep Time
Sweep Mode	Fast (up to 100x faster than Performance), Performance, No FFT, Burst Detect (1000x Fast in 15 MHz span)
Triggers	Free Run, External, Video, IF Power, Force Trigger Once
Trigger Parameters	Delay, Level, Slope, Hysteresis, Holdoff (availability varies with trigger)

Trace Functions

Traces	Up to three Traces (A, B, C), View/Blank, Write/Hold, Trace A/B/C Operations
Trace A Operations	Normal, Max Hold, Min Hold, Average, # of Averages, (always the live trace)
Trace B Operations	A → B, B ← → C, Max Hold, Min Hold
Trace C Operations	A → C, B ← → C, Max Hold, Min Hold, A - B → C, B - A → C, Relative Reference (dB), Scale

Marker Functions

Markers	Markers 1-6 each with a Delta Marker, or Marker 1 Reference with Six Delta Markers, Marker Table (On/Off/Large), All Markers Off
Marker Types	Style (Fixed/Tracking), Noise Marker, Frequency Counter Marker
Marker Auto-Position	Peak Search, Next Peak (Right/Left), Peak Threshold %, Set Marker to Channel, Marker Frequency to Center, Delta Marker to Span, Marker to Reference Level
Marker Table	1-6 markers frequency and amplitude, plus delta markers frequency offset and amplitude

Limit Line Functions

Available Spans	> 0 Hz
Limit Lines	Upper/Lower, On/Off, Edit, Move, Envelope, Advanced, Limit Alarm, Default Limit
Limit Line Edit	Frequency, Amplitude, Add Point, Add Vertical, Delete Point, Next Point Left/Right
Limit Line Move	To Current Center Frequency, By dB or Hz, To Marker 1, Offset from Marker 1
Limit Line Envelope	Create Envelope, Update Amplitude, Number of Points (2-41), Offset, Shape Square/Slope
Limit Line Advanced	Type (Absolute/Relative), Mirror, Save/Recall
Save on Event	When Limit Crossed

Frequency

Frequency Range	(usable to 0 Hz)
MS2036C	9 kHz to 9 GHz
MS2037C	9 kHz to 15 GHz
MS2038C	9 kHz to 20 GHz
Tuning Resolution	1 Hz
Frequency Reference	Aging: $\pm 1.0 \times 10^{-6}$ per year for 10 years Accuracy: $\pm 0.3 \times 10^{-6}$ (25 °C \pm 25 °C) plus aging (see Option 31 for improved frequency reference accuracy)
External Frequency Reference (MHz)	1, 1.2288, 1.544, 2.048, 2.4576, 4.8, 4.9152, 5, 9.8304, 10, 13, 19.6608 (auto-sensing)
Sweep Time	7 μs to 3600 s in zero span
Sweep Time Accuracy	$\pm 2\%$ in zero span

Bandwidth

Resolution Bandwidth (RBW)	1 Hz to 10 MHz in 1-3 sequence $\pm 10\%$ (-3 dB bandwidth)
Video Bandwidth (VBW)	1 Hz to 10 MHz in 1-3 sequence (-3 dB bandwidth)
RBW with Quasi-Peak Detection	200 Hz, 9 kHz, 120 kHz (-6 dB bandwidth)
VBW with Quasi-Peak Detection	Auto VBW is On, RBW/VBW = 1
VBW/Average Type	Linear/Log

Spectrum Analyzer Performance Specifications (MS203xC only) (continued)

Spectral Purity – SSB Phase Noise

Offset from 1 GHz	Maximum	Typical
10 kHz	-102 dBc/Hz	-106 dBc/Hz
100 kHz	-106 dBc/Hz	-110 dBc/Hz
1 MHz	-111 dBc/Hz	-116 dBc/Hz
10 MHz	-123 dBc/Hz	-129 dBc/Hz

Amplitude Ranges

Dynamic Range	>106 dB minimum at 2.4 GHz, 2/3 (TOI-DANL) in 1 Hz RBW
Measurement Range	DANL to +30 dBm
Display Range	1 to 15 dB/div in 1 dB steps, ten divisions displayed
Reference Level Range	-150 dBm to +30 dBm
Attenuator Resolution	0 to 65 dB, 5.0 dB steps
Reference Level Offset	99.9 dB External Loss to 99.9 dB External Gain
Amplitude Units	Log Scale Modes: dBW, dBm, dBμW, dBV, dBmV, dBμV, dBA, dBmA, dBμA Linear Scale Modes: fV, nV, μV, mV, V, fW, pW, nW, μW, mW, W, pA, nA, μA, mA, A
Maximum Continuous Input	+30 dBm Peak typical, ± 50 VDC (≥ 10 dB Attenuation) +23 dBm Peak typical, ± 50 VDC (< 10 dB Attenuation) +13 dBm Peak typical, ± 50 VDC (Preamp = On)

Amplitude Accuracy (excluding effects of VSWR, noise, and spurs)

	20 °C to 30 °C		-10 °C to 55 °C	
	(after 30 minute warm-up)		(after 60 minute warm-up)	
	Maximum	Typical	Maximum	Typical
9 kHz to 100 kHz ^a	±2.3 dB	±0.5 dB	±2.3 dB	±0.5 dB
> 100 kHz to 13 GHz	±1.3 dB	±0.5 dB	±2.3 dB	±0.5 dB
> 13 GHz to 18 GHz	±2.3 dB	±0.5 dB	±3.3 dB	±0.5 dB
> 18 GHz to 20 GHz	-	±1.0 dB	-	±1.0 dB

a. Values below 100 kHz are with the preamplifier turned off.

Displayed Average Noise Level (DANL) (RMS Detection, VBW/Avg Type = Log, Ref Level = -20 dBm for Preamp Off and -50 dBm for Preamp On, Auto Attenuation, Performance Sweep Mode)

	Preamp = Off		Preamp = On	
	Maximum	Typical	Maximum	Typical
10 MHz to 4 GHz	-145 dBm	-148 dBm	-161 dBm	-164 dBm
> 4 GHz to 9 GHz	-142 dBm	-145 dBm	-159 dBm	-162 dBm
> 9 GHz to 13 GHz	-136 dBm	-139 dBm	-156 dBm	-159 dBm
> 13 GHz to 20 GHz	-136 dBm	-142 dBm	-155 dBm	-161 dBm

Spurs (0 dB input attenuation)

	Preamp = Off		Preamp = On	
	Maximum	Typical	Maximum	Typical
Residual Spurs (RF input terminated)				
< 13 GHz	-90 dBm		-100 dBm	
13 GHz to 20 GHz	-85 dBm		-100 dBm	
Input-Related Spurious (-30 dBm input)	-60 dBc ^a		-70 dBc typical	

a. Instrument centered on single signal, span < 1.7 GHz

Third-Order Intercept (TOI) (-20 dBm tones 100 kHz apart, 0 dB Attenuation Preamp OFF, Reference Level -20 dBm)

2.4 GHz	+14 dBm minimum
50 MHz to 20 GHz	+20 dBm typical

P1dB

< 4 GHz	+5 dBm nominal
4 GHz to 20 GHz	+12 dBm nominal

Second Harmonic Distortion (0 dB input attenuation, -30 dBm input)

50 MHz	-54 dBc maximum
< 4 GHz	-60 dBc typical
≥ 4 GHz	-75 dBc typical

VSWR (≥ 10 dB input attenuation)

≤ 20 GHz	1.5:1 typical
----------	---------------



High Accuracy Power Meter (Option 19) (Requires external USB power sensor, sold separately)

Amplitude	Maximum, Minimum, Offset, Relative On/Off, Units, Auto Scale				
Average	# of Running Averages, Max Hold				
Zero/Cal	Zero On/Off, Cal Factor (Center Frequency, Signal Standard)				
Limits	Limit On/Off, Limit Upper/Lower				
Power Sensor Model	MA24105A	MA24106A	MA24108A/18A/26A	MA24208A/18A	MA24330A/40A/50A
Description	Inline High Power Sensor	High Accuracy RF Power Sensor	Microwave USB Power Sensor	Microwave Universal USB Power Sensor	Microwave CW USB Power Sensor
Frequency Range	350 MHz to 4 GHz	50 MHz to 6 GHz	10 MHz to 8/18/26 GHz	10 MHz to 8/18 GHz	10 MHz to 33/40/50 GHz
Connector	Type N(f), 50 Ω	Type N(m), 50 Ω	Type N(m), 50 Ω (8/18 GHz) Type K(m), 50 Ω (26 GHz)	Type N(m), 50 Ω	Type K(m), 50 Ω (33/40 GHz) Type V(m), 50 Ω (50 GHz)
Dynamic Range	+3 dBm to +51.76 dBm (2 mW to 150 W)	-40 dBm to +23 dBm (0.1 μW to 200 mW)	-40 dBm to +20 dBm (0.1 μW to 100 mW)	-60 dBm to +20 dBm (1 nW to 100 mW)	-70 dBm to +20 dBm (0.1 nW to 100 mW)
Measurand	True-RMS	True-RMS	True-RMS, Slot Power, Burst Average Power	True-RMS, Slot Power, Burst Average Power	Average Power
Measurement Uncertainty	± 0.17 dB ^a	± 0.16 dB ^b	± 0.18 dB ^c	± 0.17 dB ^d	± 0.17 dB ^e
Data sheet (for complete specifications)	11410-00621	11410-00424	11410-00504	11410-00841	11410-00906

- Notes:
- a. Expanded uncertainty with K=2 for power measurements of a CW signal greater than +20 dBm with a matched load. Measurement results referenced to the input side of the sensor.
 - b. Total RSS measurement uncertainty (0 °C to 50 °C) for power measurements of a CW signal greater than -20 dBm with zero mismatch errors.
 - c. Expanded uncertainty with K=2 for power measurements of a CW signal greater than -20 dBm with zero mismatch errors.
 - d. Power uncertainty expressed with two sigma confidence level for CW measurement after zero operation. Includes calibration factor and linearity over temperature uncertainties, but not the effects of mismatch, zero set and drift, or noise.
 - e. Includes linearity over temperature uncertainties, but not the effects of calibration factor, mismatch, zero set and drift, and noise.



Interference Analyzer (Option 25)

Measurements

Spectrum	Field Strength Occupied Bandwidth Channel Power Adjacent Channel Power (ACPR) AM/FM/SSB Demodulation (Wide/Narrow FM, Upper/Lower SSB), (audio out only) Carrier-to-Interference ratio (C/I)
Spectrogram	Collect data up to 72 hours
Signal Strength	Gives visual and aural indication of signal strength
Received Signal Strength Indicator (RSSI)	Collect data up to 168 hours (one week)
Interference Mapping	Draw multiple bearings of signal strength from GPS location on on-screen map Pan and Zoom on-screen maps Support for Anritsu MA2700A Handheld Interference Hunter
Impedance	50 Ω, 75 Ω; external pad required for 75 Ω operation



Channel Scanner (Option 27)

General

Number of Channels	1 to 20 Channels (Power Levels)
Measurements	Graph/Table, Max Hold (On/5 s/Off), Frequency/Channel, Current/Maximum, Dual Color
Scanner	Scan Channels, Scan Frequencies, Scan Custom List, Scan Script Master™
Amplitude	Reference Level, Scale
Custom Scan	Number of Channels, Signal Standard & Channel, Frequency, Bandwidth
Frequency Range	9 kHz to 9, 15, or 20 GHz
Frequency Accuracy	± 10 Hz + frequency reference error
Measurement Range	-110 dBm to +30 dBm
Impedance	50 Ω, 75 Ω; external pad required for 75 Ω operation



Coverage Mapping (Option 431)

Measurements

Indoor Mapping	RSSI, ACPR
Outdoor Mapping	RSSI, ACPR

Setup Parameters

Mode	Spectrum Analyzer
Frequency	Center, Span (ACPR only), Freq Step, Signal Standard, Channel #, Channel Increment
Amplitude	Reference Level (RL), Attenuation Auto/Level, RL Offset, Pre-Amp On/Off, Detection
Span	RSSI Mode: Zero Span ACPR Mode: Span, Span Up/Down (1-2-5), Full Span, Last Span
BW	RBW, Auto RBW, VBW, Auto VBW, RBW/VBW Ratio, Span/RBW Ratio
Measurement Setup	RSSI: Mapping color thresholds ACPR: Main Ch BW, Adj Ch BW, Ch Spacing, Adjacent Ch dB Offset, Thresholds for Good and Poor main channel levels
Mapping Colors	RSSI: Dark Green (Excellent), Light Green (Very Good), Yellow (Good), Orange (Fair), Dark Red (Poor) ACPR: Dark Green (Good), Yellow (between Good and Poor), Dark Red (Poor)
Point Distance or Time Setup	Repeat Type: Time (100 ms to 16 s), Distance (1 m to 10,000 m) Distance Units: m, ft
Save Points Map	Save KML, JPEG, Tab Delimited
Recall Points Map	Recall Map, Recall KML Points only, Recall KML Points with Map, Recall Default Grid
Map Types	Outdoor (GPS embedded), Indoor (non-GPS embedded). Import maps using the Anritsu easyMap Tools. Zoomable (.azm) maps are usable, but cannot be zoomed.

GPS Receiver (Option 31) (requires external GPS antenna, sold separately)

Setup	On/Off, Antenna Voltage 3.3 V/5.0 V, GPS Info
GPS Time/Location Indicator	UTC Time, Latitude, Longitude, and Altitude on display (UTC Time and Altitude on GPS Info display) UTC Time, Latitude, Longitude, and Altitude with trace storage
High Frequency Accuracy	< ± 2.5 × 10 ⁻⁸ Hz/Hz with GPS On, 3 minutes after satellite lock in selected mode (GPS Antenna connected) < ± 5.0 × 10 ⁻⁸ Hz/Hz for 3 days after GPS lock, 0 °C to 50 °C (GPS Antenna disconnected)
Connector	SMA, female



AM/FM/PM Signal Analyzer (Option 509, MS203xC only)

Measurements

Display Type	RF Spectrum (AM/FM/PM)	Audio Spectrum (AM)	Audio Spectrum (FM/PM)	Audio Waveform (AM)	Audio Waveform (FM/PM)	Summary (AM)	Summary (FM/PM)
Graphic Display	Power (dBm) vs. Frequency	Depth (%) vs. Modulation Frequency	Deviation (kHz/rad) vs. Modulation Frequency	Depth (%) vs. Time	Deviation (kHz/rad) vs. Time	None	None
Numerical Displays	Carrier Power Carrier Frequency Occupied BW	AM Rate RMS Depth (Pk-Pk)/2 Depth SINAD* THD* Distortion/Total Vrms*	FM/PM Rate RMS Deviation (Pk-Pk)/2 Deviation SINAD* THD* Distortion/Total Vrms*	AM Rate RMS Depth (Pk-Pk)/2 Depth SINAD* THD* Distortion/Total Vrms*	FM/PM Rate RMS Deviation (Pk-Pk)/2 Deviation SINAD* THD* Distortion/Total Vrms*	RMS Depth Peak + Depth Peak - Depth (Pk-Pk)/2 Depth Carrier Power Carrier Frequency Occupied Bandwidth AM Rate SINAD* THD* Distortion/Total Vrms*	RMS Deviation Peak + Deviation Peak - Deviation (Pk-Pk)/2 Deviation Carrier Power Carrier Frequency Occupied Bandwidth FM/PM Rate SINAD* THD* Distortion/Total Vrms*

* Requires sine wave modulation

Setup Parameters

Frequency	Center Freq, Span, Freq Step, Signal Standard, Channel, Channel Increment, Set (measured) Carrier Freq to Center
Amplitude Setup	Scale, Power Offset, Adjust Range
Measurements	RF Spectrum, Audio Spectrum (demodulated), Audio Waveform (demodulated), Summary, Coverage Mapping (Option 431 required), Audio Demod (AM/FM only)
Measurement Setup	All Measurements: Demod Type (AM, FM, PM), IFBW, Auto IFBW, Squelch Units, Distortion Measurements (Sinewave or Broadcast) RF Spectrum: OBW Method, OBW %, OBW dBC Audio Spectrum: Span, Scale, Squelch Power Audio Waveform: Sweep Time, Scale, Squelch Power Summary: Average count, Squelch Power Coverage Mapping: Measurement (SINAD, Carrier Power, Multiple), Thresholds, Point Distance/Time Audio Demod: Demod Type (AM, USB, LSB, Widband FM, Narrowband FM), Volume, Squelch
Mapping Colors	Dark Green (Excellent), Light Green (Very Good), Orange (Good), Yellow (Fair), Dark Red (Poor)
Marker	Six markers with Delta for each, Peak Search, Marker Freq to Center, Marker to Ref Lvl, Marker Table

RF and Modulation Measurements

AM	Modulation Rate: ± 1 Hz (< 100 Hz), ± 2 % (> 100 Hz) Depth: ± 5 % for (Modulation rates 10 Hz to 100 kHz)
FM	Modulation Rate: ± 1 Hz (< 100 Hz); ± 2 % (100 Hz to 100 kHz) Deviation Accuracy: ± 5 % (100 Hz to 100 kHz)**
PM	Modulation Rate: ± 1 Hz (< 100 Hz); ± 2 % (100 Hz to 100 kHz) Deviation Accuracy: ± 5 % (deviation 0 to 93 Rad, rate 10 Hz to 5 kHz)**
IF Bandwidth	1 kHz to 300 kHz in 1-3 sequence
Frequency Span	RF Spectrum: 10 kHz to 10 MHz Audio Spectrum: 2 kHz, 5 kHz, 10 kHz, 20 kHz, 70 kHz, 140 kHz
RBW/VBW	30
Span/RBW	100
Sweep Time	50 μ s to 50 ms (Audio Waveform)
**	IFBW must be greater than 95 % occupied BW

General Specifications

System Parameters	System	Status (Temperature, Battery Info, Serial Number, Firmware Version, IP Address, Options Installed) Self Test, Application Self Test, GPS (see Option 31)
	System Options	Name, Date and Time, Ethernet Configuration, Brightness, Volume, Language (English, French, German, Spanish, Chinese, Japanese, Korean, Italian, Russian, Portuguese), Reset (Factory Defaults, Master Reset, Update Firmware)
	Internal Trace/Setup Memory	Store more than 4000 traces and setups in memory
	External Trace/Setup Memory	Limited by size of USB Flash drive
	Mode Switching	Auto-Stores/Recalls most recently used Setup Parameters in the Mode
File Management	File Types	Vary with measurement mode
	File	Save, Recall, Copy, Delete
	Save	Setups, Measurements, Screen Shots (JPEG)
	Recall	Setups, Measurements
	Copy	Selected file or files to internal/external memory (USB)
	Delete	Selected file or files from internal/external memory (USB)
	File Sort Method	By Name/Date/Type, Ascend/Descend
Connectors	VNA Connectors	Type N, female (or ruggedized K female with Option 11, MS20x7C or MS20x8C only) (x2)
	Maximum Input (Damage Level)	Vector Network Analyzer Input: +23 dBm, \pm 50 VDC (all models) Spectrum Analyzer Input: +30 dBm, \pm 50 VDC (MS203xC models only)
	Spectrum Analyzer Connectors	Type N, female (or ruggedized K female with Option 11, MS2037C or MS2038C only)
	Bias Tee	Type BNC female (enabled with Option 10) (x2)
	Ext Ref	Type BNC, female, 10 MHz, \pm 10 dBm
	GPS	SMA female (available with Option 31 GPS)
	External Power	5.5 mm barrel connector, 12 VDC to 14.5 VDC, < 5.0 A
	Ethernet	RJ45, 10/100 Mbps, Connect to PC or LAN for Remote Access
	USB Interface (2)	Type A, Connect Flash Drive and Power Sensor
	USB Interface	5-pin mini-B, Connect to PC for data transfer
	Headset Jack	3.5 mm 3-wire headset jack
	External Trigger	BNC, female, TTL 3.3 V or 5 V triggers on positive edge, Maximum Input + 5 VDC
	10 MHz Out	SMA, female, 50 Ω
Display	Size	8.4 in, daylight viewable color LCD
	Resolution	800 x 600
	Pixel Defects	No more than five defective pixels (99.9989% good pixels)
Power	Field replaceable Li-Ion Battery	40 W when powered by factory 7500 mAh Li-Ion battery (part number: 633-75)
	AC/DC Power Adapter	55 W when powered by supplied universal 110/220 V AC/DC adaptor while charging battery
	Life-time Charging Cycles	> 300 (80 % of initial capacity)
	Battery Operation	3.0 hours typical
	Battery Charging Limits	0 °C to +45 °C, Relative Humidity \leq 80 %, non-condensing
Regulatory Compliance	European Union	EMC 2014/30/EU, EN 61326:2013, CISPR 11/EN 55011, IEC/EN 61000-4-2/3/4/5/6/8/11 Low Voltage Directive 2014/35/EU, Safety EN 61010-1:2010 RoHS Directive 2011/65/EU applies to instruments with CE marking placed on the market after July 22, 2017
	Australia and New Zealand	RCM AS/NZS 4417:2012
	Canada	ICES-1(A)/NMB-1(A)
	South Korea	KCC-REM-A21-0004
	Environmental	MIL-PRF-28800F Class 2
Operating Temperature Range	-10 °C to 55 °C	
Storage Temperature Range	-51 °C to 71 °C	
Maximum Relative Humidity	95 % RH at 30 °C, non-condensing	
Vibration, Sinusoidal	5 Hz to 55 Hz	
Vibration, Random	10 Hz to 500 Hz	
Half Sine Shock	30 g _n	
Altitude	4600 meters, operating and non-operating	
Explosive Atmosphere	MIL-PRF-28800F Section 4.5.6.3, MIL-STD-810G, Method 511.5, Procedure 1	
Size and Weight	Dimensions	Height: 211 mm (8.3 in) Width: 315 mm (12.4 in) Depth: 78 mm (3.1 in) (MS202xC), 97 mm (3.8 in) (MS203xC)
	Weight, Including Battery	4.5 kg (9.9 lb) (MS202xC), 4.8 kg (10.5 lb) (MS203xC)
	Warranty	Standard three-year warranty One-year warranty on battery



Line Sweep Tools™ (for your PC)

Trace Capture

Browse to Instrument	View and copy traces from the test equipment to your PC using Windows Explorer
Open Legacy Files	Open DAT files captured with Handheld Software Tools v6.61
Open Current Files	Open VNA or DAT files
Capture Plots To	The Line Sweep Tools screen, DAT files, Database, or JPEG

Traces

Trace Types	Return Loss, VSWR, DTF-RL, DTF-VSWR, Cable Loss, Smith Chart, and PIM
Trace Formats	DAT, VNA, CSV, PNG, BMP, JPG, HTML, Database, and PDF

Report Generation

Report Generator	Includes GPS location along with measurements
Report Format	Create reports in HTML or PDF format
Report Setup	Report Title, Company, Prepared for, Location, Date and Time, Filename, Company logo
Trace Setup	1 Trace Portrait Mode, 2 Trace Portrait Mode, 1 Trace Landscape Mode

Trace Validation

Presets	7 presets allow “one click” setting of up to 6 markers and one limit line
Marker Controls	6 regular Markers, Marker Peak, Marker Valley, Marker between, and frequency entry
Delta Markers	6 Delta markers
Limit Line	Enable and drag or value entry. Also works with presets
Next Trace Button	Next Trace and Previous Trace arrow keys allow quick switching between traces

Tools

Cable Editor	Allows creation of custom cable parameters
Distance to Fault	Converts a Return Loss trace to a Distance to Fault trace
Measurement Calculator	Converts Real, Imaginary, Magnitude, Phase, RL, VSWR, Rho, and Transmit power
Signal Standard Editor	Creates new band and channel tables
Renaming Grid	36 user-definable phrases for creation of file names, trace titles, and trace subtitles

Connectivity

Connections	Connect to PC using Serial, USB, or Ethernet
Download	Download measurements and live traces to PC for storage and analysis
Upload	Upload measurements from PC to instrument



Master Software Tools (for your PC)

Measurement Viewing

Display	Modify display settings, including scale
Spectrum Traces	Add, delete, and modify limit lines and markers. Overlay traces.
Spectrum Analyzer Measurements	Field Strength, Occupied Bandwidth, Channel Power, ACPR, Emission Mask, C/I ¹
Interference Analyzer Measurements	Spectrograms, Signal Strength Meter, RSSI ²
Non-Spectrum Measurements	Hi Accuracy Power Meter, Channel Scanner, GSM, WCDMA/HSPA, LTE, TD-LTE, TD-SCDMA, CDMA, EV-DO, Fixed WiMAX, Mobile WiMAX, Screen captures (JPEGs)
	1. Spurious Emissions results viewable in a browser
	2. Coverage and Interference Mapping files are viewable in a spreadsheet, Google Earth, or Google Maps.

Database Management

Full Trace Retrieval	Retrieve all traces from instrument into one PC directory (limited to approximately 15,000 files)
Trace Catalog	Index all traces in selected folder & subfolder on PC into one catalog
Trace Rename Utility	Rename measurement traces
Group Edit	Titles, subtitles, plot scaling, markers and limit lines, simultaneously on similar files

Data Analysis

Trace Math and Smoothing	Compare multiple traces
Measurement Calculator	Translate into other units

Report Generation

Report Generator	Includes GPS, power level, and measurements
Edit Graph	Change scale, limit lines, and markers
Report Format	Create reports in HTML
Export Measurements	Export measurements or entire folders to *.jpg or *.csv format
Notes	Annotate measurements

Mapping (GPS required on instrument)

Spectrum Analyzer Mode	MapInfo
LTE Mode	Google Earth, Google Maps

Spectrogram (Spectrum Monitoring for Interference Analysis and Spectrum Clearing)

Source	Recorded Spectrogram or multiple spectrum traces
Folder Spectrogram	2D View creates a composite file of multiple traces
Available Displays	Spectrogram, Peak Power vs. Time, Variation in Total Power vs. Time, Peak Frequency vs. Time, Number of Traces Saved vs. Time (useful with Save on Limit Exceeded), Maximum/Average/Minimum Power vs. Time
	File Filter (Violations over limit lines or deviations from averages)
	Playback
Display Functions per Trace	Markers, GPS location altitude and time (when recorded), instrument time
	Filename per trace for Folder Spectrogram
Export to Video	Create AVI file of 2D Spectrogram for management review/reports
Export to 3D Spectrogram	Views (Set Threshold, Markers)
	- 3D (Rotate X, Y, Z Axis, Level Scale, Signal ID)
	- 2D (Frequency or Time Domain, Signal ID)
	- Top Down
	Playback (Frequency and/or Time Domain)

List/Parameter Editors

Antennas, Cables, Signal Standards	Modify instrument's Antenna, Cable, and Signal Standard List
Pass/Fail	Create, download, or edit Signal Analysis Pass/Fail Limits
Script Master	Create Script Master files for GSM/WCDMA or Channel Scanner
Languages	Modify non-English language menus
Mobile WiMAX	DL-MAP Parameters

Connectivity

Connections	Connect to PC using USB, LAN, or Direct Ethernet connection
Network Search	Find all Anritsu handheld instruments on local network
Download	Download measurements and live traces to PC for storage and analysis
Upload	Upload measurements and other files from PC to instrument
Remote Access Tool	Remote control and monitoring of instrument (via Ethernet port) over the Internet
Export	Measurements can be saved in various formats, depending on the measurement type, including JPEG, CSV, and Anritsu DAT format
Printing	Print individual or all measurement screens

Ordering Information

VNA Master™ Handheld Vector Network Analyzer + Spectrum Analyzer						Description
MS2026C	MS2027C	MS2028C	MS2036C	MS2037C	MS2038C	
5 kHz to 6 GHz	5 kHz to 15 GHz	5 kHz to 20 GHz	5 kHz to 6 GHz 9 kHz to 9 GHz	5 kHz to 15 GHz 9 kHz to 15 GHz	5 kHz to 20 GHz 9 kHz to 20 GHz	Vector Network Analyzer Spectrum Analyzer
MS2026C-0002	MS2027C-0002	MS2028C-0002	MS2036C-0002	MS2037C-0002	MS2038C-0002	Time Domain (includes Distance Domain capabilities)
MS2026C-0007	MS2027C-0007	MS2028C-0007	MS2036C-0007	MS2037C-0007	MS2038C-0007	Secure Data Operation
MS2026C-0010	MS2027C-0010	MS2028C-0010	MS2036C-0010	MS2037C-0010	MS2038C-0010	Built-in Bias-Tee
	MS2027C-0011	MS2028C-0011		MS2037C-0011	MS2038C-0011	K(f) Test Port Connectors (MS20x7C & MS20x8C only)
MS2026C-0015	MS2027C-0015	MS2028C-0015	MS2036C-0015	MS2037C-0015	MS2038C-0015	Vector Voltmeter
MS2026C-0019	MS2027C-0019	MS2028C-0019	MS2036C-0019	MS2037C-0019	MS2038C-0019	High Accuracy Power Meter (requires external USB sensor)
			MS2036C-0025	MS2037C-0025	MS2038C-0025	Interference Analysis, ^a 9 kHz to 9/15/20 GHz
			MS2036C-0027	MS2037C-0027	MS2038C-0027	Channel Scanner, ^a 9 kHz to 9/15/20 GHz
MS2026C-0031	MS2027C-0031	MS2028C-0031	MS2036C-0031	MS2037C-0031	MS2038C-0031	GPS Receiver (requires GPS antenna, 2000-1528-R, 2000-1652-R, or 2000-1760-R)
MS2026C-0077	MS2027C-0077	MS2028C-0077	MS2036C-0077	MS2037C-0077	MS2038C-0077	Balanced/Differential S-Parameters, 1-Port
			MS2036C-0431	MS2037C-0431	MS2038C-0431	Coverage Mapping ^b
MS2026C-0098	MS2027C-0098	MS2028C-0098	MS2036C-0098	MS2037C-0098	MS2038C-0098	Standard Calibration to ISO17025 and ANSI/NCSL Z540-1. Includes calibration certificate.
MS2026C-0099	MS2027C-0099	MS2028C-0099	MS2036C-0099	MS2037C-0099	MS2038C-0099	Premium Calibration to ISO17025 and ANSI/NCSL Z540-1. Includes calibration certificate, test report, and uncertainty data.
			MS2036C-0509	MS2037C-0509	MS2038C-0509	AM/FM/PM Analyzer ^c

a. Option 31 (GPS) is recommended.

b. Requires Option 31 (GPS) for full functionality.

c. Requires Option 431 (Coverage Mapping) for full functionality.

Related Literature, Application Notes, Manuals

Part Number	Description
10100-00065	Product Information, Compliance, and Safety
10580-00349	Spectrum Analyzer Measurement Guide
10580-00240	Power Meter Measurement Guide
10580-00289	VNA Measurement Guide
10580-00305	VNA Master User Guide
10580-00306	VNA Master Programming Manual
10580-00307	VNA Master Maintenance Manual
11410-00387	Primer on Vector Network Analysis
11410-00424	USB Power Sensor MA24106A
11410-00472	Measuring Interference
11410-00504	Microwave USB Power Sensor MA241x8A
11410-00531	Practical Tips on Making "Vector Voltmeter (VVM)" Phase Measurements using VNA Master (Option 15)
11410-00545	VNA Master + Spectrum Analyzer Brochure
11410-00549	VNA Master + Spectrum Analyzer Technical Data Sheet
11410-00700	Evaluation of RF Network Testing

Standard Accessories (included with instrument)



Part Number	Description
2000-1685-R	Soft Carrying Case (supplied with MS202xC only)
2000-1686-R	Soft Carrying Case (supplied with MS203xC only)
633-75	Rechargeable Li-Ion Battery
40-187-R	AC-DC Adapter
806-141-R	Automotive Power Adapter, 12 VDC, 60 W
3-2000-1498	USB A/5-pin Mini-B Cable, 3.05 m (10 ft)
2000-1371-R	Ethernet Cable, 2.13 m (7 ft)
	Certificate of Calibration and Conformance

Optional Accessories

Miscellaneous Accessories



Part Number	Description
MA2700A	Handheld Interference Hunter (For full specifications, refer to the MA2700A Technical Data Sheet 11410-00692)
2000-1371-R	Ethernet Cable, 2.1 m (7 ft)
3-806-152	Cat 5e Crossover Patch Cable, 2.1 m (7 ft)
633-75	Rechargeable Li-Ion Battery, 7500 mAh
2000-1374-R	External Dual Charger for Li-Ion Batteries
2000-1689-R	EMI Near Field Probe Kit
66864	Rack Mount Kit

GPS Antennas (active)



Part Number	Description
2000-1652-R	Magnet Mount, SMA(m), 3 VDC to 5 VDC with 1 ft cable
2000-1528-R	Magnet Mount, SMA(m), 3 VDC to 5 VDC with 4.6 m (15 ft) extension cable
2000-1760-R	Mini GPS Antenna, SMA(m), 25 dB gain, 2.5 VDC to 3.7 VDC

Backpack and Transit Case



Part Number	Description
67135	Anritsu Backpack (for handheld instrument and PC)
760-243-R	Transit Case with Wheels and Handle 56 cm x 45.5 cm x 26.5 cm (22.07" x 17.92" x 10.42")
760-261-R	Large Transit Case with Wheels and Handle 63.1 cm x 50 cm x 30 cm (24.83" x 19.69" x 11.88"), space for MA2700A, antennas, filters, instrument inside soft case, and other interference hunting accessories/tools
760-262-R	Transit Case for MA2700A, several Yagi antennas and filters
760-271-R	Transit Case for Portable Directional Antennas and Port Extender 52.4 cm x 42.8 cm x 20.6 cm (20.62" x 16.87" x 8.12") (for 2000-1777-R, 2000-1778-R, 2000-1779-R, 2000-1798-R)
760-286-R	Compact Transit Case with Wheels and Handle 55.6 cm x 35.5 cm x 22.9 cm (21.89" x 13.98" x 9.01")

Power Sensors (for complete ordering information, see the respective data sheets of each sensor)



Model Number	Description
MA24105A	Inline Peak Power Sensor, 350 MHz to 4 GHz, +3 dBm to +51.76 dBm
MA24106A	RF USB Power Sensor, 50 MHz to 6 GHz, +23 dBm
MA24108A	Microwave USB Power Sensor, 10 MHz to 8 GHz, +20 dBm
MA24118A	Microwave USB Power Sensor, 10 MHz to 18 GHz, +20 dBm
MA24126A	Microwave USB Power Sensor, 10 MHz to 26 GHz, +20 dBm
MA24208A	Microwave Universal USB Power Sensor, 10 MHz to 8 GHz, +20 dBm
MA24218A	Microwave Universal USB Power Sensor, 10 MHz to 18 GHz, +20 dBm
MA24330A	Microwave CW USB Power Sensor, 10 MHz to 33 GHz, +20 dBm
MA24340A	Microwave CW USB Power Sensor, 10 MHz to 40 GHz, +20 dBm
MA24350A	Microwave CW USB Power Sensor, 10 MHz to 50 GHz, +20 dBm
MA25100A	RF Power Indicator

Full Temperature Coaxial Calibration Kits (-10 °C to +55 °C , K Type is compatible with 3.5 mm and SMA connectors see individual data sheets on www.anritsu.com)



Part Number	Description
OSLN50A-8	High Performance Type N(m), DC to 8 GHz, 50 Ω
OSLNF50A-8	High Performance Type N(f), DC to 8 GHz, 50 Ω
TOSLN50A-8	High Performance with Through Type N(m), DC to 8 GHz, 50 Ω
TOSLNF50A-8	High Performance with Through Type N(f), DC to 8 GHz, 50 Ω
OSLN50A-18	High Performance Type N(m), DC to 18 GHz, 50 Ω
OSLNF50A-18	High Performance Type N(f), DC to 18 GHz, 50 Ω
TOSLN50A-18	High Performance with Through Type N(m), DC to 18 GHz, 50 Ω
TOSLNF50A-18	High Performance with Through Type N(f), DC to 18 GHz, 50 Ω
TOSLK50A-20	High Performance with Through Type K(m), DC to 20 GHz, 50 Ω
TOSLKF50A-20	High Performance with Through Type K(f), DC to 20 GHz, 50 Ω
TOSLK50A-40	High Performance with Through Type K(m), DC to 40 GHz, 50 Ω
TOSLKF50A-40	High Performance with Through Type K(f), DC to 40 GHz, 50 Ω

Coaxial Calibration Components, N Type 50 Ω, K Type 50 Ω (K Type is compatible with 3.5 mm and SMA connectors)



Part Number	Description
22N50	Precision Open/Short, N(m), DC to 18 GHz, 50 Ω
22NF50	Precision Open/Short, N(f), DC to 18 GHz, 50 Ω
28N50-2	Precision Load, N(m), DC to 18 GHz, 50 Ω
28NF50-2	Precision Load, N(f), DC to 18 GHz, 50 Ω
22K50	Precision Open/Short, K(m), DC to 40 GHz, 50 Ω
22KF50	Precision Open/Short, K(f), DC to 40 GHz, 50 Ω
28K50	Precision Load, K(m), DC to 40 GHz, 50 Ω
28KF50	Precision Load, K(f), DC to 40 GHz, 50 Ω

Coaxial Calibration Components, Other 50 Ω, 75 Ω



Part Number	Description
2000-1618-R	Precision Open/Short/Load, 7/16 DIN(m), DC to 6.0 GHz 50 Ω
2000-1619-R	Precision Open/Short/Load, 7/16 DIN(f), DC to 6.0 GHz 50 Ω
2000-1914-R	Precision Open/Short/Load, 4.3-10(f), DC to 6 GHz, 50 Ω
2000-1915-R	Precision Open/Short/Load, 4.3-10(m), DC to 6 GHz, 50 Ω
12N50-75B	Matching Pad, DC to 3 GHz, 50 Ω to 75 Ω
22N75	Open/Short, N(m), DC to 3 GHz, 75 Ω
22NF75	Open/Short, N(f), DC to 3 GHz, 75 Ω
26N75A	Precision Termination, N(m), DC to 3 GHz, 75 Ω
26NF75A	Precision Termination, N(f), DC to 3 GHz, 75 Ω
SM/PL-1	Precision N(m) Load, 42 dB, 6 GHz
SM/PLNF-1	Precision N(f) Load, 42 dB, 6 GHz
1091-55-R	Open, TNC(f), DC to 18 GHz
1091-53-R	Open, TNC(m), DC to 18 GHz
1091-56-R	Short, TNC(f), DC to 18 GHz
1091-54-R	Short, TNC(m), DC to 18 GHz
1015-54-R	Termination, TNC(f), DC to 18 GHz
1015-55-R	Termination, TNC(m), DC to 18 GHz

Precision Adapters



Part Number	Description
34NN50A	Precision Adapter, N(m) to N(m), DC to 18 GHz, 50 Ω
34NFN50	Precision Adapter, N(f) to N(f), DC to 18 GHz, 50 Ω
34NK50	Precision Adapter, DC to 18 GHz, N(m) to K(m), 50 Ω
34NKF50	Precision Adapter, DC to 18 GHz, N(m) to K(f), 50 Ω
K220B	Precision Adapter, DC to 40 GHz, K(m) to K(f), 50 Ω
K222B	Precision Adapter, DC to 40 GHz, K(f) to K(f), 50 Ω
K224B	Precision Adapter, DC to 40 GHz, K(m) to K(f), 50 Ω

Waveguide Calibration Components and WG/Coaxial Adapters, Rectangular Type 50 Ω

Recommended waveguide calibration procedure requires two offset shorts and a precision load. The waveguide/coax adapter, shown attached to test port #1, adapts the VNA Master test ports to the waveguide under test.



Frequency Range (GHz)	1/8 Offset	3/8 Offset	Termination	Coax to Waveguide Adapter	Compatible Flanges
3.95 to 5.85	23UA187-R	24UA187-R	26UA187-R	35UA187N-R	CPR187F-R, CPR187G-R, UG-1352/U-R, UG-1353/U-R, UG-1728/U-R, UG-1729/U-R, UG-148/U-R, UG-149A/U-R
5.85 to 8.20	23UA137-R	24UA137-R	26UA137-R	35UA137N-R	CPR137F-R, CPR137G-R, UG-1356/U-R, UG-1357/U-R, UG-1732/U-R, UG-1733/U-R, UG-343B/U-R, UG-344/U-R, UG-440B/U-R, UG-441/U-R
7.05 to 10.00	23UA112-R	24UA112-R	26UA112-R	35UA112N-R	CPR112F-R, CPR112G-R, UG-1358/U-R, UG-1359/U-R, UG-1734/U-R, UG-1735/U-R, UG-52B/U-R, UG-51/U-R, UG-137B/U-R, UG-138/U-R
8.20 to 12.40	23UA90-R	24UA90-R	26UA90-R	35UA90N-R	CPR90F-R, CPR90G-R, UG-1360/U-R, UG-1361/U-R, UG-1736/U-R, UG-1737/U-R, UG-40B/U-R, UG-39/U-R, UG-135/U-R, UG-136B/U-R
12.40 to 18.00	23UA62-R	24UA62-R	26UA62-R	35UA62N-R	UG-541A/U-R, UG-419/U-R, UG-1665/U-R, UG1666/U-R
17.00 to 26.50	23UA42-R	24UA42-R	26UA42-R	35UA42K-R	UG-596A/U-R, UG-595/U-R, UG-597/U-R, UG-598A/U-R
26.50 to 40.00	23UA28-R	24UA28-R	26UA28-R	35UA28K-R	UG-599/U-R
3.30 to 4.90	23UM40-R	24UM40-R	26UM40-R	35UM40N-R	PDR40-R
3.95 to 5.85	23UM48-R	24UM48-R	26UM48-R	35UM48N-R	CAR48-R, PAR48-R, UAR48-R, PDR48-R
5.85 to 8.20	23UM70-R	24UM70-R	26UM70-R	35UM70N-R	CAR70-R, PAR70-R, UAR 70-R, PDR70-R
7.05 to 10.00	23UM84-R	24UM84-R	26UM84-R	35UM84N-R	CBR84-R, UBR84-R, PBR84-R, PDR84-R
8.20 to 12.40	23UM100-R	24UM100-R	26UM100-R	35UM100N-R	CBR100-R, UBR100-R, PBR100-R, PDR100-R
10.00 to 15.00	23UM120-R	24UM120-R	26UM120-R	35UM120N-R	CBR120-R, UBR120-R, PBR120-R, PDR120-R
12.40 to 18.00	23UM140-R	24UM140-R	26UM140-R	35UM140N-R	CBR140-R, UBR140-R, PBR140-R, PDR140-R
17.00 to 26.50	23UM220-R	24UM220-R	26UM220-R	35UM220K-R	CBR220-R, UBR220-R, PBR220-R, PDR220-R

* For Coaxial/Waveguide Adapter part numbers, N designates Type N and K designates K-Connector

Phase-Stable Test Port Extension Cables (Armored and Flexible)



Part Number	Description
14KFKF50-0.6	0.6 m (24 in), DC to 40 GHz, K(f) to K(f), 50 Ω
14KFKF50-1.0	1.0 m (39 in), DC to 40 GHz, K(f) to K(f), 50 Ω
14KFK50-0.6	0.6 m (24 in), DC to 40 GHz, K(f) to K(m), 50 Ω
14KFK50-1.0	1.0 m (39 in), DC to 40 GHz, K(f) to K(m), 50 Ω
15NNS50-1.0B	1.0 m (39 in), DC to 18 GHz, N(m) to N(m), 50 Ω
15NNF50-1.0B	1.0 m (39 in), DC to 18 GHz, N(m) to N(f), 50 Ω
15LL50-1.0A	1.0 m (39 in), DC to 20 GHz, 3.5 mm(m) to 3.5 mm(m), 50 Ω
15LLF50-1.0A	1.0 m (39 in), DC to 20 GHz, 3.5 mm(m) to 3.5 mm(f), 50 Ω
15KK50-1.0A	1.0 m (39 in), DC to 26.5 GHz, K(m) to K(m), 50 Ω
15KKF50-1.0A	1.0 m (39 in), DC to 26.5 GHz, K(m) to K(f), 50 Ω

Phase-Stable Test Port Cables, Armored



Part Number	Description
15NNF50-1.5C	1.5 m, DC to 6 GHz, N(m) to N(f), 50 Ω
15NN50-1.5C	1.5 m, DC to 6 GHz, N(m) to N(m), 50 Ω
15NDF50-1.5C	1.5 m, DC to 6 GHz, N(m) to 7/16 DIN(f), 50 Ω
15ND50-1.5C	1.5 m, DC to 6 GHz, N(m) to 7/16 DIN(m), 50 Ω
15NNF50-3.0C	3.0 m, DC to 6 GHz, N(m) to N(f), 50 Ω
15NN50-3.0C	3.0 m, DC to 6 GHz, N(m) to N(m), 50 Ω
15NNF50-5.0C	5.0 m, DC to 6 GHz, N(m) to N(f), 50 Ω
15NN50-5.0C	5.0 m, DC to 6 GHz, N(m) to N(m), 50 Ω
15N43M50-1.5C	Test Port Extension Cable, Armored, 1.5 meters, DC to 6GHz, N(m) to 4.3-10(m)
15N43F50-1.5C	Test Port Extension Cable, Armored, 1.5 meter, DC to 6GHz, N(m) to 4.3-10(f)
15N43M50-3.0C	Test Port Extension Cable, Armored, 3 meters, DC to 6 GHz, N(m) to 4.3-10(m)
15N43F50-3.0C	Test Port Extension Cable, Armored, 3 meters, DC to 6 GHz, N(m) to 4.3-10(f)

Phase-Stable 18 GHz and 40 GHz Semi-Rigid Cables (Armored)



Part Number	Description
3670K50-1	0.3 m (12 in), DC to 40 GHz, K(f) to K(m), 50 Ω
3670K50-2	0.6 m (24 in), DC to 40 GHz, K(f) to K(m), 50 Ω
3670N50-1	0.3 m (12 in), DC to 18 GHz, N(f) to N(m), 50 Ω
3670NN50-1	0.3 m (12 in), DC to 18 GHz, N(m) to N(m), 50 Ω
3670N50-2	0.6 m (24 in), DC to 18 GHz, N(f) to N(m), 50 Ω
3670NN50-2	0.6 m (24 in), DC to 18 GHz, N(m) to N(m), 50 Ω

Attenuators N Type (up to 18 GHz)



Part Number	Description
3-1010-122	20 dB, 5 W, DC to 12.4 GHz, N(m) to N(f)
42N50-20	20 dB, 5 W, DC to 18 GHz, N(m) to N(f)
42N50A-30	30 dB, 5 W, DC to 18 GHz, N(m) to N(f)
3-1010-123	30 dB, 50 W, DC to 8.5 GHz, N(m) to N(f)
1010-127-R	30 dB, 150 W, DC to 3 GHz, N(m) to N(f)
3-1010-124	40 dB, 100 W, DC to 8.5 GHz, N(f) to N(m), Uni-directional
1010-121-R	40 dB, 100 W, DC to 18 GHz, N(f) to N(m), Uni-directional
1010-128-R	40 dB, 150 W, DC to 3 GHz, N(m) to N(f)

Attenuators K Type (up to 40 GHz)



Part Number	Description
41KB-3	Precision Fixed Attenuator, K(m) to K(f), 3 dB, DC to 26.5 GHz, 50 Ω
41KB-6	Precision Fixed Attenuator, K(m) to K(f), 6 dB, DC to 26.5 GHz, 50 Ω
41KB-10	Precision Fixed Attenuator, K(m) to K(f), 10 dB, DC to 26.5 GHz, 50 Ω
41KB-20	Precision Fixed Attenuator, K(m) to K(f), 20 dB, DC to 26.5 GHz, 50 Ω
41KC-3	Precision Fixed Attenuator, K(m) to K(f), 3 dB, DC to 40 GHz, 50 Ω
41KC-6	Precision Fixed Attenuator, K(m) to K(f), 6 dB, DC to 40 GHz, 50 Ω
41KC-10	Precision Fixed Attenuator, K(m) to K(f), 10 dB, DC to 40 GHz, 50 Ω
41KC-20	Precision Fixed Attenuator, K(m) to K(f), 20 dB, DC to 40 GHz, 50 Ω

Adapters



Part Number	Description
1091-26-R	DC to 18 GHz, N(m) to SMA(m), 50 Ω
1091-27-R	DC to 18 GHz, N(m) to SMA(f), 50 Ω
1091-80-R	DC to 18 GHz, N(f) to SMA(m), 50 Ω
1091-81-R	DC to 18 GHz, N(f) to SMA(f), 50 Ω
1091-172-R	DC to 1.3 GHz, N(m) to BNC(f), 50 Ω
1091-465-R	DC to 6 GHz, 4.3-10(f) to N(f), 50 Ω
1091-467-R	DC to 6 GHz, 4.3-10(m) to N(f), 50 Ω
510-90-R	DC to 7.5 GHz, 7/16 (f) to N(m), 50 Ω
510-91-R	DC to 7.5 GHz, 7/16 (f) to N(f), 50 Ω
510-92-R	DC to 7.5 GHz, 7/16 (m) to N(m), 50 Ω
510-93-R	DC to 7.5 GHz, 7/16 (m) to N(f), 50 Ω
510-96-R	DC to 7.5 GHz, 7/16 DIN(m) to 7/16 DIN(m), 50 Ω
510-97-R	DC to 7.5 GHz, 7/16 DIN(f) to 7/16 DIN(f), 50 Ω
513-62-R	DC to 18 GHz, TNC(f) to N(f), 50 Ω
1091-315-R	DC to 18 GHz, TNC(m) to N(f), 50 Ω
1091-324-R	DC to 18 GHz, TNC(f) to N(m), 50 Ω
1091-325-R	DC to 18 GHz, TNC(m) to N(m), 50 Ω
1091-317-R	DC to 18 GHz, TNC(m) to SMA(f), 50 Ω
1091-318-R	DC to 18 GHz, TNC(m) to SMA(m), 50 Ω
1091-323-R	DC to 18 GHz, TNC(f) to TNC(f), 50 Ω
1091-326-R	DC to 18 GHz, TNC(m) to TNC(m), 50 Ω
510-102-R	DC to 11 GHz, N(m)-N(m), 90 degrees, 50 Ω
34RKNF50	DC to 18 GHz, Ruggedized K(m) to N(f), 50 Ω

GPS Antennas (active)



Part Number	Description
2000-1528-R	Magnet Mount, SMA(m) with 5 m (16.4 ft) cable, requires 5 VDC
2000-1652-R	Magnet Mount, SMA(m) with 0.3 m (1 ft) cable, requires 3.3 VDC or 5 VDC
2000-1760-R	Miniature Antenna, SMA(m), requires 2.5 VDC to 3.7 VDC

Directional Antennas



Part Number	Description
2000-1411-R	824 MHz to 896 MHz, N(f), 12.3 dBi, Yagi
2000-1412-R	885 MHz to 975 MHz, N(f), 12.6 dBi, Yagi
2000-1413-R	1710 MHz to 1880 MHz, N(f), 12.3 dBi, Yagi
2000-1414-R	1850 MHz to 1990 MHz, N(f), 11.4 dBi, Yagi
2000-1415-R	2400 MHz to 2500 MHz, N(f), 14.1 dBi, Yagi
2000-1416-R	1920 MHz to 2170 MHz, N(f), 14.3 dBi, Yagi
2000-1659-R	698 MHz to 787 MHz, N(f), 10.1 dBi, Yagi
2000-1660-R	1425 MHz to 1535 MHz, N(f), 14.3 dBi, Yagi
2000-1715-R	Directional Antenna, 698 MHz to 2500 MHz, N(f), gain of 2 dBi to 10 dBi, typical
2000-1726-R	Antenna, 2500 MHz to 2700 MHz, N(f), 14.1 dBi, Yagi
2000-1747-R	Antenna, Log Periodic, 300 MHz to 7000 MHz, N(f), 5.1 dBi, typical
2000-1748-R	Antenna, Log Periodic, 1 GHz to 18 GHz, N(f), 6 dBi, typical
2000-1777-R	Portable Directional Antenna, 9 kHz to 20 MHz, N(f)
2000-1778-R	Portable Directional Antenna, 20 MHz to 200 MHz, N(f)
2000-1779-R	Portable Directional Antenna, 200 MHz to 500 MHz, N(f)
2000-1812-R	Portable Yagi Antenna, 450 MHz to 512 MHz, N(f), 7.1 dBi
2000-1825-R	Portable Yagi Antenna, 380 MHz to 430 MHz, N(f), 7.1 dBi

Mag Mount and Broadband Antennas



Part Number	Description
2000-1616-R	20 MHz to 21000 MHz, N(f), 50 Ω
2000-1645-R	694 MHz to 894 MHz, 3 dBi peak gain 1700 MHz to 2700 MHz, 3 dBi peak gain, N(m), 50 Ω, 10 ft
2000-1646-R	750 MHz to 1250 MHz, 3 dBi peak gain, 1650 MHz to 2700 MHz, 5 dBi peak gain
2000-1647-R	Cable 1: 698 MHz to 1200 MHz, 2 dBi peak gain, 1700 MHz to 2700 MHz, 5 dBi peak gain, N(m), 50 Ω, 10 ft Cable 2: 3000 MHz to 6000 MHz, 5 dBi peak gain, N(m), 50 Ω, 10 ft Cable 3: GPS 26 dB gain, SMA(m), 50 Ω, 10 ft
2000-1946-R	Cable 1: 617 MHz to 960 MHz, 3 dBi peak gain, 1710 MHz to 3700 MHz, 4 dBi peak gain, N(m), 50 Ω, 10 ft Cable 2: 3000 MHz to 6000 MHz, 5 dBi peak gain, N(m), 50 Ω, 10 ft Cable 3: GPS 26 dB gain, SMA(m), 50 Ω, 10 ft
2000-1648-R	1700 MHz to 6000 MHz, 3 dBi peak gain, N(m), 50 Ω, 10 ft

Portable Antennas



Part Number	Description
2000-1200-R	806 MHz to 866 MHz, SMA(m), 50 Ω
2000-1473-R	870 MHz to 960 MHz, SMA(m), 50 Ω
2000-1035-R	896 MHz to 941 MHz, SMA(m), 50 Ω (1/2 wave)
2000-1030-R	1710 MHz to 1880 MHz, SMA(m), 50 Ω (1/2 wave)
2000-1474-R	1710 MHz to 1880 MHz with knuckle elbow (1/2 wave)
2000-1031-R	1850 MHz to 1990 MHz, SMA(m), 50 Ω (1/2 wave)
2000-1475-R	1920 MHz to 1980 MHz and 2110 MHz to 2170 MHz, SMA(m), 50 Ω
2000-1032-R	2400 MHz to 2500 MHz, SMA(m), 50 Ω (1/2 wave)
2000-1361-R	2400 MHz to 2500 MHz, 5000 MHz to 6000 MHz, SMA(m), 50 Ω
2000-1751-R	698 MHz to 960 MHz, 1710 MHz to 2100 MHz, 2500 MHz to 2700 MHz, SMA(m), 2 dB typical, 50 Ω
2000-1487-R	VHF/UHF, Telescopic Whip antenna, straight or 90°, BNC(m), 50 Ω
2000-1636-R	Antenna Kit (Consists of: 2000-1030-R, 2000-1031-R, 2000-1032-R, 2000-1200-R, 2000-1035-R, 2000-1361-R, and carrying pouch)

Bandpass Filters



Part Number	Description
1030-114-R	806 MHz to 869 MHz, N(m) to SMA(f), 50 Ω
1030-109-R	824 MHz to 849 MHz, N(m) to SMA(f), 50 Ω
1030-110-R	880 MHz to 915 MHz, N(m) to SMA(f), 50 Ω
1030-111-R	1850 MHz to 1910 MHz, N(m) to SMA(f), 50 Ω
1030-112-R	2400 MHz to 2484 MHz, N(m) to SMA(f), 50 Ω
1030-105-R	890 MHz to 915 MHz, N(m) to N(f), 50 Ω
1030-106-R	1710 MHz to 1790 MHz, N(m) to N(f), 50 Ω
1030-107-R	1910 MHz to 1990 MHz, N(m) to N(f), 50 Ω
1030-149-R	High Pass, 150 MHz, N(m) to N(f), 50 Ω
1030-150-R	High Pass, 400 MHz, N(m) to N(f), 50 Ω
1030-151-R	High Pass, 700 MHz, N(m) to N(f), 50 Ω
1030-152-R	Low Pass, 200 MHz, N(m) to N(f), 50 Ω
1030-153-R	Low Pass, 550 MHz, N(m) to N(f), 50 Ω
1030-155-R	2500 MHz to 2700 MHz, N(m) to N(f), 50 Ω
1030-178-R	1920 MHz to 1980 MHz, N(m) to N(f), 50 Ω
1030-179-R	777 MHz to 798 MHz, N(m) to N(f), 50 Ω
1030-180-R	2500 MHz to 2570 MHz, N(m) to N(f), 50 Ω
2000-1684-R	791 MHz to 821 MHz, N(m) to N(f), 50 Ω
2000-1734-R	Bandpass Filter, 699 MHz to 715 MHz, N(m) and N(f), 50 Ω
2000-1735-R	Bandpass Filter, 776 MHz to 788 MHz, N(m) and N(f), 50 Ω
2000-1736-R	Bandpass Filter, 815 MHz to 850 MHz, N(m) and N(f), 50 Ω
2000-1737-R	Bandpass Filter, 1711 MHz to 1756 MHz, N(m) and N(f), 50 Ω
2000-1738-R	Bandpass Filter, 1850 MHz to 1910 MHz, N(m) and N(f), 50 Ω
2000-1739-R	Bandpass Filter, 880 MHz to 915 MHz, N(m) and N(f), 50 Ω
2000-1740-R	Bandpass Filter, 1710 MHz to 1785 MHz, N(m) and N(f), 50 Ω
2000-1741-R	Bandpass Filter, 1920 MHz to 1980 MHz, N(m) and N(f), 50 Ω
2000-1742-R	Bandpass Filter, 832 MHz to 862 MHz, N(m) and N(f), 50 Ω
2000-1743-R	Bandpass Filter, 2500 MHz to 2570 MHz, N(m) and N(f), 50 Ω
2000-1799-R	Bandpass Filter, 2305 MHz to 2320 MHz, N(m) and N(f), 50 Ω
2000-1911-R	Bandpass Filter, 703 MHz to 748 MHz, N(m) and N(f), 50 Ω
2000-1912-R	Bandpass Filter, 788 MHz to 798 MHz, N(m) and N(f), 50 Ω
2000-1925-R	Bandpass Filter, 663 MHz to 698 MHz, N(m) and N(f), 50 Ω
2000-1926-R	Bandpass Filter, 776 MHz to 806 MHz, N(m) and N(f), 50 Ω

NEON® MA8100A Signal Mapper (supported on MS2036C, MS2037C, MS2038C models only)

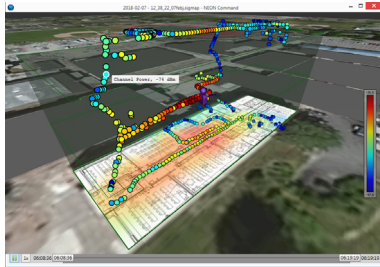

Model Number Description

- MA8100A-000 NEON Signal Mapper with Anritsu Integration and Tracking Unit. Includes 1 year NEON Software License with 1 year of maintenance and support and 1 year of Cloud Service (PN: 2300-607).
- MA8100A-001 NEON Signal Mapper with Anritsu Integration and Tracking Unit. Includes 1 year NEON Software License with 1 year of maintenance and support and 1 year of Cloud Service (PN: 2300-574).
- MA8100A-003 NEON Signal Mapper with Anritsu Integration and Tracking Unit. Includes 3 year NEON Software License with 3 years of maintenance and support and 3 years of Cloud Service (PN: 2300-575).
- MA8100A-005 NEON Signal Mapper with Anritsu Integration and Tracking Unit. Includes 5 year NEON Software License with 5 years of maintenance and support and 5 years of Cloud Service (PN: 2300-576).
- MA8100A-100 NEON Signal Mapper with Anritsu Integration and Tracking Unit. Includes Perpetual NEON Software License with 3 years of maintenance and support and 3 years of Cloud Service (PN: 2300-606).
 - 2300-606 Perpetual NEON Software License with 3 years of maintenance and support and 3 years of Cloud Service. Part number can also be used to order a perpetual license after a limited term license has expired.
 - 2300-612 Renewal of 1 year NEON Software License with 1 year of maintenance and support and 1 year of Cloud Service.
 - 2300-613 Renewal of 3 year NEON Software License with 3 years of maintenance and support and 3 years of Cloud Service.
 - 2300-614 Renewal of 5 year NEON Software License with 5 years of maintenance and support and 5 years of Cloud Service.
- 2000-1852-R NEON Tracking Unit (includes USB cable and belt clip, Worldwide version)
- 2000-2015-R NEON Tracking Unit (includes USB cable and belt clip, Japan version)
- 2000-1853-R Belt clip (for NEON Tracking Unit)